

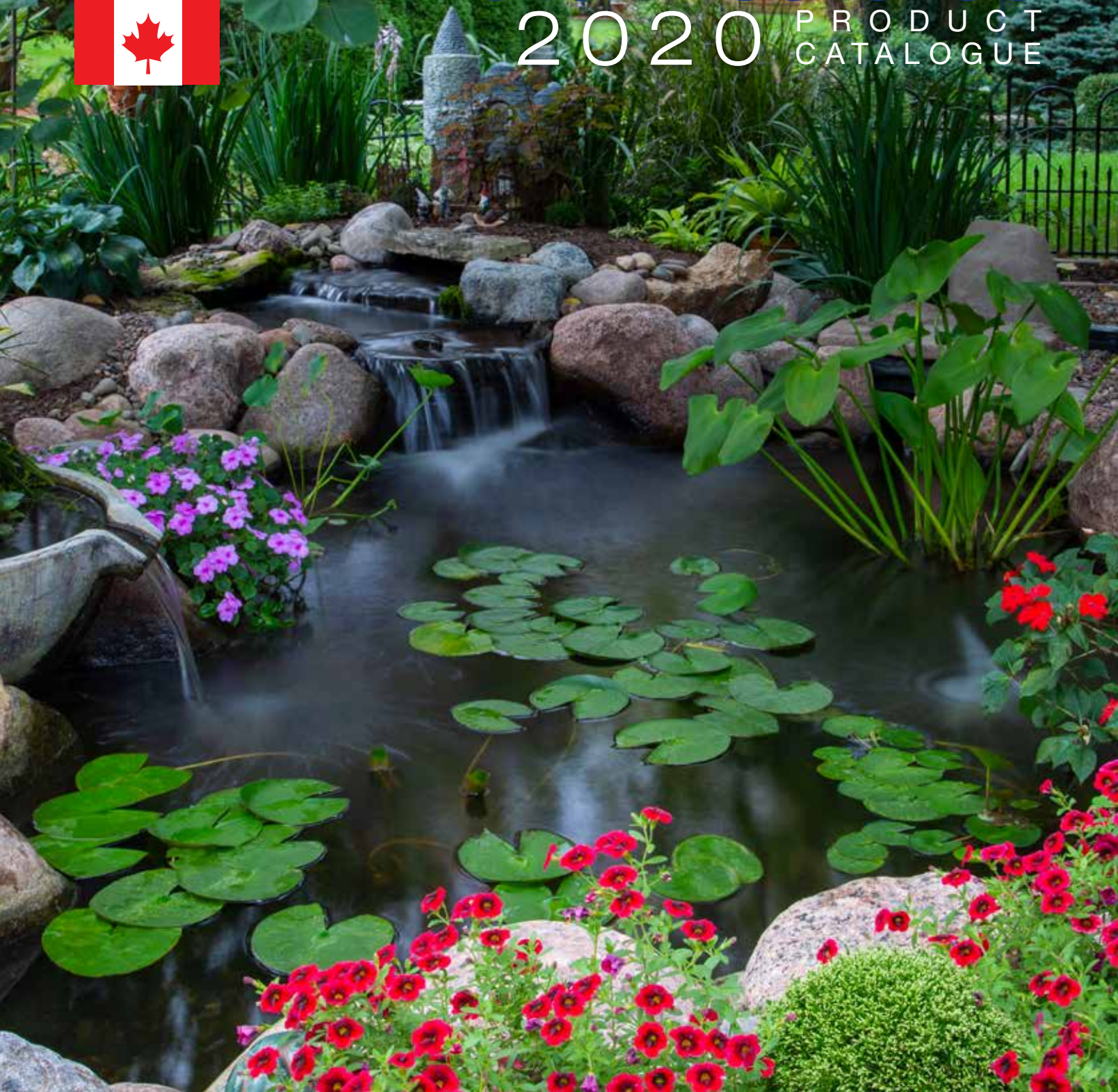

Water Features

2020 PRODUCT CATALOGUE



The leading water feature manufacturer in North America

Thank you for 29 years of support!

Your Paradise. Our Passion.® That's our motto at Aquascape. We strive each and every day to provide the best products and services in the water feature industry.

Whether you are experienced or new to the world of water features, we invite you to explore our comprehensive selection of products designed to build, enhance, and maintain a wide variety of water features, including ponds, waterfalls, and fountains.





From our expansive selection of high-quality products with long-term warranties to our industry-leading training events and experienced Customer Care and Technical Support teams, we are here to ensure your success installing, selling, or enjoying Aquascape water features.

Welcome to Living the Aquascape Lifestyle™!

*Greg Wittstock
"The Pond Guy"*





LIVING THE AQUASCAPE LIFESTYLE™

At **Aquascape**, our passion is helping people transform their outdoor living space and how they spend their leisure time. Living the Aquascape Lifestyle™ is about enjoying your own personal retreat with a beautiful water feature. When you live with a pond, waterfall, or fountain, you are drawn outside, away from daily stresses, to interact with your landscape in a variety of ways. Water feature owners enjoy feeding colorful fish, watching birds splash in a waterfall, or listening to the tranquil sounds of moving water. The benefits are plentiful, and Aquascape makes it easier than ever to enjoy the Aquascape Lifestyle.

TABLE OF CONTENTS

■ Pond Kits	8	■ Predator Control	93
■ Pondless® Waterfall Kits	13	■ Seasonal Care	94
■ Landscape Fountain Kits.	18	■ Fish Care	97
■ Filtration	21	■ Aquatic Plant Care	102
■ Pumps	38	■ Decorative	104
■ Aeration	56	■ Liner, Underlayment, and Geotextile .	120
■ Lighting.	60	■ Pipe and Plumbing	123
■ Power.	73	■ Installation Tools	127
■ Water Treatments	75	■ Rainwater Harvesting	130

SYMBOL KEY

	Use with Smart Control App		2-Year Limited Warranty
	Fire Fountain Add-On Kit Available		3-Year Limited Warranty
	Ideal for Cold Weather		5-Year Limited Warranty
	Great for Container Water Gardens		Limited Lifetime Warranty
	New Product		



INTRODUCING THE NEW Aquascape Smart Control App



Use Your Smartphone To Control Your Aquascape Water Feature

Download the Smart Control App* to

- Control adjustable flow pumps
- Change Aquascape color-changing lights
- Monitor power consumption
- Manage your water feature at anytime from anywhere



Smart Control Plug - The easiest way to control existing water features, allowing you to control lights, pumps, or any other outdoor appliance at anytime from anywhere using the Smart Control App on your smartphone or tablet.

[See page 74 for more information.](#)



Smart Control Receiver - Makes it easy to connect your adjustable flow pump to the Smart Control App on your smartphone or tablet, providing a variety of wireless control functions, including flow adjustment and customized scheduling.

Includes:

- Conversion Plug for converting older model Adjustable Flow Pumps to WiFi

[See page 39 for more information.](#)



Smart Control Hub for color-changing lights - Control your lights from anywhere using the Smart Control App on your smartphone or tablet, providing a variety of lighting functions, including color selection, cycle, dimming, color themes, and more.

[See page 68 for more information.](#)

* App available for download in January 2020

NEW Aquascape Products

NEW



SLD Adjustable Flow Pond Pumps - Professional-grade, solids-handling, asynchronous pumps that allow you to use your smartphone to control flow rates and customized scheduling.

[See page 42 for more information.](#)



Waterfall Spillway 12" - Introducing a smaller version of the popular 22" wide Waterfall Spillway, providing smooth, consistent, leak free waterfalls.

[See page 32 for more information.](#)



AquaSurge® and AquaForce® Adjustable Flow Pumps - Now available with Smart Control Receivers.

[See page 40 and 48 for more information.](#)



Deluxe Pond Kits - A medium and large pond kit with all the components you need to build a pond and plenty of extras, like the Pond Powerhead, Faux Driftwood 30" and our adjustable flow pump and color-changing lights now controlled by the Smart Control App.

[See page 12 for more information.](#)



Faux Log Fish Cave - Provides a great place for your pond fish to hide from predators or take shelter from the sun. This realistic-looking decorative accent adds aesthetic appeal to a pond.

[See page 109 for more information.](#)



Deluxe Pondless® Waterfall Kits - A medium and large Pondless Waterfall Kit with all the components you need to build a waterfall and plenty of extras, like the Faux Driftwood 35" and our adjustable flow pump and color-changing lights now controlled by the Smart Control App.

[See page 17 for more information.](#)



AquaGarden Mini Pond Kit - Complete pond and water garden kit, containing an integrated plant and waterfall filter, waterfall light, water pump, and media kit.

[See page 106 for more information.](#)



POND KITS

Transform your outdoor living space with a beautiful ecosystem pond that can be created with a convenient kit. The Aquascape approach to creating backyard pond kits is to provide a complete low-maintenance system that works with Mother Nature for a naturally balanced pond with clean, healthy water. All pond kit components selected work well together and complement the addition of rocks, gravel, fish, and plants. Aquascape offers a variety of pond kit sizes to suit your space.

Pond Kits

The Ecosystem Pond

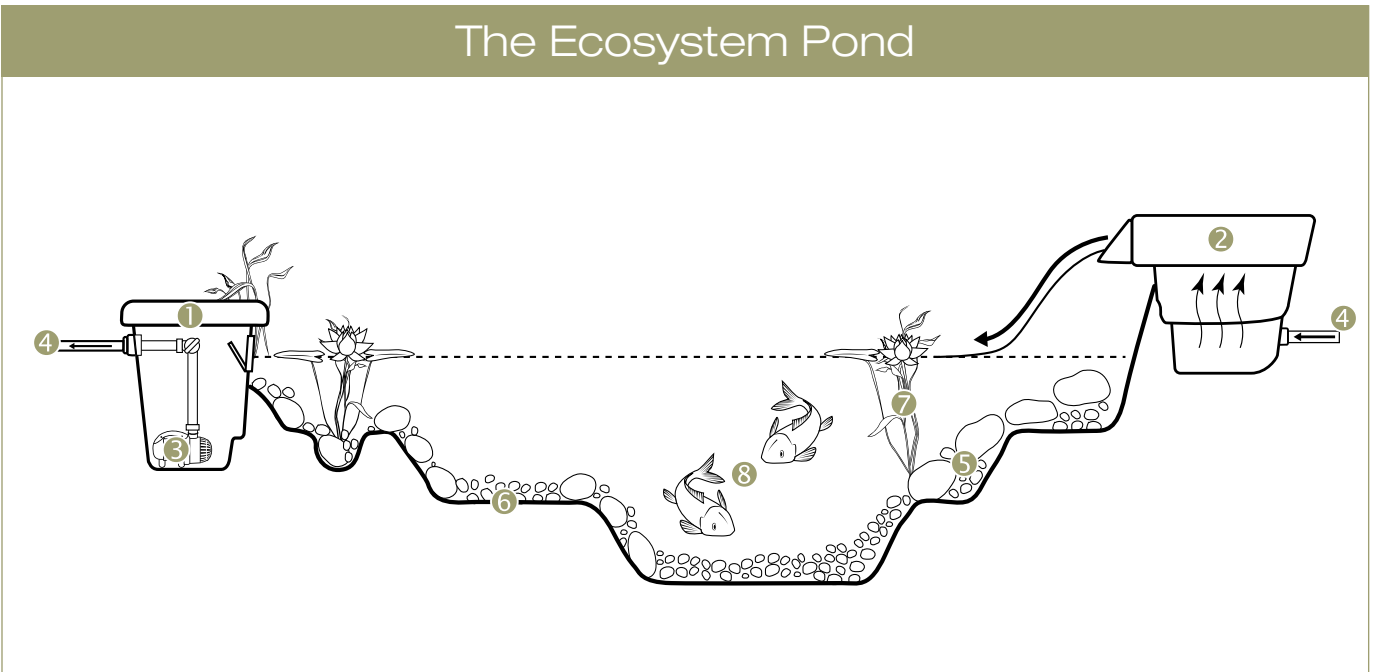

- ① Pond Skimmer
Pre-filters water and houses pump, collects debris, and reduces maintenance
- ② BioFalls® Filter
Provides surface area for beneficial bacteria to colonize and remove excess nutrients from the water
- ③ Pond Pump
Pumps water from the Pond Skimmer to the BioFalls Filter to create a waterfall
- ④ Pipe
Directs water from the skimmer to the BioFalls Filter
- ⑤ Rocks and Gravel (not included)
Protects the liner, naturalizes the pond bottom, and provides surface area for beneficial bacteria to break down excess nutrients
- ⑥ Pond Liner and Underlayment
Forms the pond's foundation, containing the water and allowing for gases to escape from beneath the pond
- ⑦ Plants (not included)
Aquatic plants filter pond water, thereby minimizing maintenance and improving water conditions.
- ⑧ Fish (not included)
Provide nutrients for pond plants and reduce maintenance

Professional Grade Pond Kits

Aquascape Professional Grade Pond Kits are available in three sizes for those looking to build a pond with professional-grade products.



Small Pond Kit 8' x 11'
#53033 MSRP \$2,299.99



Medium Pond Kit 11' x 16'
with AquaSurge® 2000–4000 Adjustable Flow
Pond Pump
#53034 MSRP \$3,799.99
with 3-PL 3000 Solids-Handling Pond Pump
#53035 MSRP \$3,799.99



Large Pond Kit 21' x 26'
with AquaSurge® 4000–8000 Adjustable Flow
Pond Pump
#53036 MSRP \$5,399.99
with 9-PL 7000 Solids-Handling Pond Pump
#53037 MSRP \$5,599.99
NEW with SLD 5000-9000
Adjustable Flow Pond Pump
#53063 MSRP \$5,599.99

Comparison Chart

Model	Small Pond Kit 8' x 11'	Medium Pond Kit 11' x 16'	Large Pond Kit 21' x 26'
Skimmer	Signature Series 400 Pond Skimmer	Signature Series 1000 Pond Skimmer	Signature Series 1000 Pond Skimmer
BioFalls	Signature Series 1000 BioFalls	Signature Series 2500 BioFalls	Signature Series 6000 BioFalls
BioFalls Rock Tray	✓	✓	✓
BioFalls Filter Media	✓	✓	✓
Pump*	AquaSurge 3000 Pond Pump	AquaSurge 2000-4000 Adjustable Flow Pond Pump (#53034) 3-PL 3000 Solids-Handling Pond Pump (#53035)	AquaSurge 4000-8000 Adjustable Flow Pond Pump (#53036) 9-PL 7000 Solids-Handling Pond Pump (#53037) SLD 5000-9000 Adjustable Flow Pond Pump (#53063)
Pipe	Flexible PVC 1.5" x 25'	Flexible PVC 2" x 25'	Flexible PVC 2" x 50'
Liner Material	45 mil EPDM (Fish Safe)	45 mil EPDM (Fish Safe)	45 mil EPDM (Fish Safe)
Liner Size*	12' x 15'	15' x 20'	25' x 30'
Finished Pond Size* Length x Width x Max Depth	8' x 11' x 2'	11' x 16' x 2'	21' x 26' x 2'
Underlayment*	180 ft ²	300 ft ²	750 ft ²
LED Lighting Package**	–	✓	✓
Automatic Dosing System	✓	✓	✓
Installation Kit***	✓	✓	✓
Welcome Kit	✓	✓	✓
Packaged Weight	145 lb	290 lb	488 lb
Packaged Dimensions	25"L x 40"W x 30"H	48"L x 40"W x 31"H Palletized	48"L x 40"W x 41"H Palletized

* Options vary based on kit size.

**LED Lighting Package includes: (2) 3-Watt LED Spotlights, 1-Watt LED Waterfall and Up Light, 60-Watt Transformer with Photocell, 3-Way Splitter and 25' Quick-Connect Extension Cable

***Installation Kit includes: Silicone Sealant, EPDM Liner Patch, Pond and Waterfall Foam Sealant, Christy's Red Hot Blue Glue
Finished pond size may vary based on pond shape and rock size.



Deluxe Pond Kits

Aquascape Deluxe Pond Kits include all components found in professional grade pond kits, but are enhanced with the addition of the Pond Powerhead, Faux Driftwood 30", and an LED color-changing light package. Connect the pump and lights to our Smart Control App and control them with your smartphone or tablet.



Medium Deluxe Pond Kit 11' x 16'
#53066 MSRP \$4,399.99



Large Deluxe Pond Kit 21' x 26'
#53067 MSRP \$6,399.99

Comparison Chart

Model	Medium Deluxe Pond Kit 11' x 16'	Large Deluxe Pond Kit 21' x 26'
Skimmer	Signature Series 1000 Pond Skimmer	Signature Series 1000 Pond Skimmer
BioFalls	Signature Series 2500 BioFalls	Signature Series 6000 BioFalls
BioFalls Rock Tray	✓	✓
BioFalls Faux Rock Lip	✓	✓
BioBalls Biological Filter Media	✓	✓
Pump*	AquaSurge 2000-4000 Adjustable Flow Pond Pump	AquaSurge 4000-8000 Adjustable Flow Pond Pump
Pond Powerhead	✓	✓
Faux Driftwood 30"	✓	✓
Pipe	Flexible PVC 2" x 25'	Flexible PVC 2" x 50'
Liner Material	45 mil EPDM (Fish Safe)	45 mil EPDM (Fish Safe)
Liner Size*	15' x 20'	25' x 30'
Finished Pond Size* Length x Width x Max Depth	11' x 16' x 2'	21' x 26' x 2'
Underlayment*	300 ft ²	750 ft ²
Pump Check Valve Assembly	✓	✓
LED Color-Changing Lighting Package**	✓	✓
Automatic Dosing System	✓	✓
Installation Kit***	✓	✓
Welcome Kit	✓	✓
Packaged Weight	315 lb	513 lb
Packaged Dimensions	48"L x 40"W x 31"H Palletized	48"L x 40"W x 41"H Palletized

* Options vary based on kit size.

**LED Color-Changing Lighting Package includes: (2) 4.5-Watt Color-Changing Spotlights, 2-Watt Color-Changing Waterfall and Up Light, Color-Changing Lighting Control Hub, 150-Watt Transformer, 3-Way Color-Changing Splitter, 25' Color-Changing Extension Cable

***Installation Kit includes: Silicone Sealant, EPDM Liner Patch, Pond and Waterfall Foam Sealant, Christy's Red Hot Blue Glue
Finished pond size may vary based on pond shape and rock size.



PONDLESS® WATERFALL KITS

A Pondless® Waterfall is simply a re-circulating waterfall or stream without the presence of a pond. Aquascape Pondless Waterfall Kits work by pumping water contained in a large, in-ground reservoir up and through the Waterfall Spillway, allowing the water to flow back down into the reservoir. This simple recirculation system requires very little maintenance, is easy to install, and ideal for families with young children or pets that love to play in water.

All waterfall kit components selected work well together to complement and enhance your existing landscape. In just one day you can enjoy the soothing sight and sound that a waterfall adds to your yard.

Pondless® Waterfall Kits

The Backyard Waterfall Landscape Fountain Kit

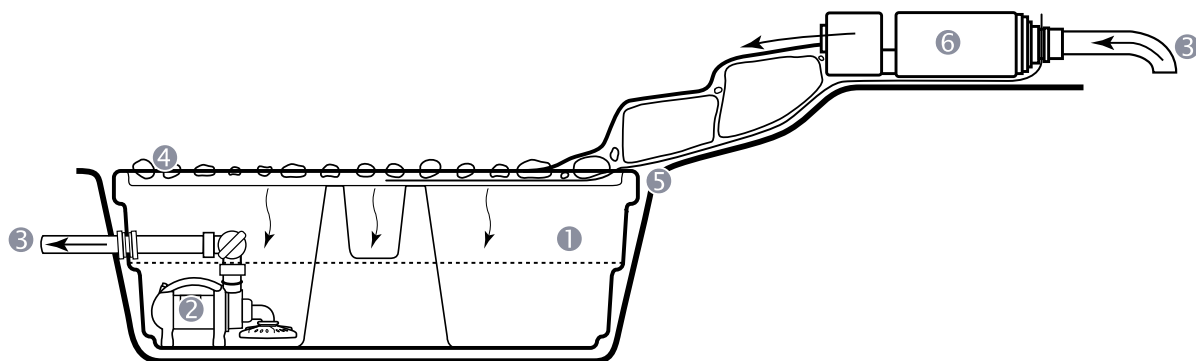

- ① AquaBasin® 45
Provides a basin for water to be stored and protects the pump
- ② Pond Pump
Pumps water from the water storage area back to the spillway to create a waterfall
- ③ Pipe
Directs water from the basin/reservoir to the Waterfall Spillway
- ④ Rocks and Gravel (not included)
Naturalizes the waterfall and filters the water
- ⑤ Liner and Underlayment
Creates the form of the waterfall and stream
- ⑥ Waterfall Spillway
Provides a smooth, flowing waterfall

The Pondless® Waterfall Kit

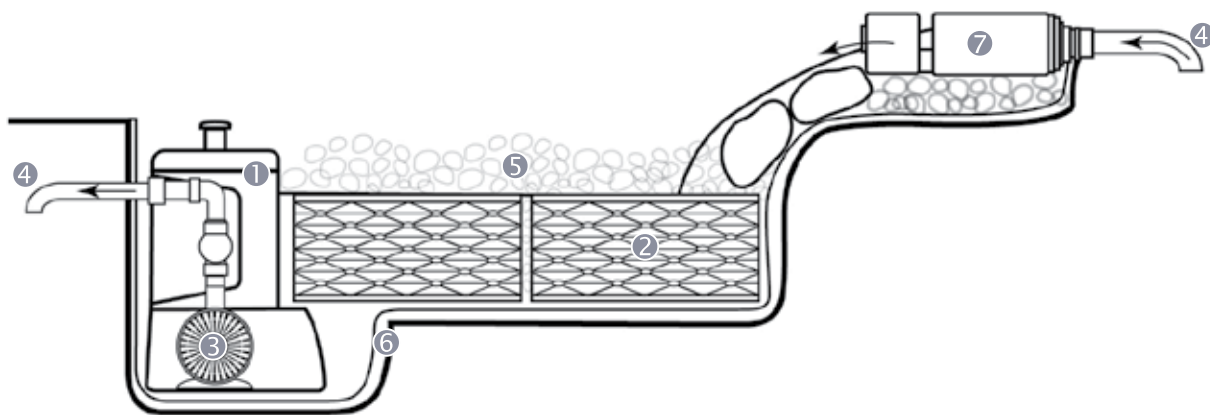

- ① Pondless® Waterfall Vault
Protects pump
- ② AquaBlox® Water Storage Modules
Provides water storage
- ③ Pond Pump
Pumps water from the underground reservoir to the spillway to create a waterfall
- ④ Pipe
Directs water from the basin/reservoir to the Waterfall Spillway
- ⑤ Rocks and Gravel (not included)
Naturalizes the waterfall and filters the water
- ⑥ Liner and Underlayment
Creates the form of the waterfall stream and holds water in the water storage area
- ⑦ Waterfall Spillway
Provides a smooth, flowing waterfall

DIY Backyard Pondless® Waterfall Kits

Aquascape offers two small waterfall kits that are perfect for the DIY customer.



Backyard Waterfall Landscape Fountain Kit
#83013 MSRP \$1,199.98



DIY Backyard Waterfall Kit
#83001 MSRP \$1,499.98

Comparison Chart

Model	Backyard Waterfall Landscape Fountain Kit	DIY Backyard Waterfall Kit
Waterfall Spillway	✓	✓
Vault/Basin	AquaBasin 45	Pondless Waterfall Vault
AquaBlox	—	(2) Small
Pump*	AquaSurge 2000 Pond Pump	EcoWave 2000 Pond Pump
Pipe	Flexible PVC 1.5" x 15'	Kink-Free 1.5" x 25'
Liner Material	45 mil EPDM (Fish Safe)	45 mil EPDM (Fish Safe)
Liner Size	7.5' x 7.5'	10' x 12'
Underlayment	✓	105 ft ²
LED Lighting Package	—	—
Automatic Dosing System	—	✓
Installation Kit**	✓	✓
Welcome Kit	✓	✓
Packaged Weight	175 lb	113 lb
Packaged Dimensions	48"L x 40"W x 35"H Palletized	41"L x 20"W x 25"H

* Options vary based on kit size.

**Installation Kit includes: Fittings, Silicone Sealant, Pond and Waterfall Foam Sealant
Finished Pondless Waterfall size may vary based on shape and rock size.

Professional Pondless® Waterfall Kits

Aquascape Professional Pondless® Waterfall Kits are available in three sizes for those who wish to build a larger waterfall with contractor-grade products.



Small Pondless® Waterfall Kit 6' Stream

#53038 MSRP \$2,299.99

Medium Pondless® Waterfall Kit 16' Stream

with AquaSurge® 2000–4000 Adjustable Flow
Pond Pump

#53039 MSRP \$2,799.99

with 3-PL 3000 Solids-Handling Pond Pump

#53040 MSRP \$2,799.99

NEW

with SLD 4000-7000
Adjustable Flow Pond Pump

#53064 MSRP \$3,099.99

Large Pondless® Waterfall Kit 26' Stream

with AquaSurge® 4000–8000 Adjustable Flow
Pond Pump

#53041 MSRP \$3,499.99

with 5-PL 5000 Solids-Handling Pond Pump

#53042 MSRP \$3,599.99

NEW

with SLD 5000-9000
Adjustable Flow Pond Pump

#53065 MSRP \$3,799.99

Comparison Chart

Model	Small Pondless Waterfall Kit 6' Stream	Medium Pondless Waterfall Kit 16' Stream	Large Pondless Waterfall Kit 26' Stream
Waterfall Spillway	✓	✓	✓
Vault/Basin	Pondless Waterfall Vault	Pondless Waterfall Vault	Pondless Waterfall Vault
AquaBlox	(3) Small	(5) Small	(5) Large
Pump*	AquaSurge 2000-4000	AquaSurge 2000-4000 Adjustable Flow Pond Pump (#53039) 3-PL 3000 Solids-Handling Pond Pump (#53040) SLD 4000-7000 Adjustable Flow Pond Pump (#53064)	AquaSurge 4000-8000 Adjustable Flow Pond Pump (#53041) 9-PL 7000 Solids-Handling Pond Pump (#53042) SLD 5000-9000 Adjustable Flow Pond Pump (#53065)
Pipe	Flexible PVC 1.5" x 25'	Flexible PVC 2" x 25'	Flexible PVC 2" x 50'
Liner Material	45 mil EPDM (Fish Safe)	45 mil EPDM (Fish Safe)	45 mil EPDM (Fish Safe)
Liner Size	10' x 10' (Reservoir) 8' x 10' (Stream)	10' x 12' (Reservoir) 10' x 20' (Stream)	10' x 15' (Reservoir) 10' x 30' (Stream)
Underlayment	100 ft ²	120 ft ²	180 ft ²
LED Lighting Package**	–	✓	✓
Automatic Dosing System	✓	✓	✓
Installation Kit**	✓	✓	✓
Welcome Kit	✓	✓	✓
Packaged Weight	149 lb	298 lb	379 lb
Packaged Dimensions	37"L x 24"W x 28"H	48"L x 40"W x 24"H Palletized	48"L x 40"W x 31"H Palletized

* Options vary based on kit size.

LED Lighting Package includes: Medium Kits (2) 1-Watt LED Waterfall and Up Lights, Large Kits (3) 1-Watt LED Waterfall and Up Lights, 60-Watt Transformer with Photocell, 3-Way Splitter and 25' Quick-Connect Extension Cable

***Installation Kit includes: Silicone Sealant, EPDM Liner Patch, Pond and Waterfall Foam Sealant, Christy's Red Hot Blue Glue
Finished Pondless Waterfall size may vary based on shape and rock size.

Deluxe Pondless® Waterfall Kits



Aquascape Deluxe Pondless® Waterfall Kits include all the components found in standard medium and large Aquascape Pondless Waterfall Kits, but are enhanced with the addition of the Faux Driftwood and an LED color-changing light package. Connect the pump and lights to the Smart Control App and control them with your smartphone or tablet.



Medium Deluxe Pondless® Waterfall Kit
16' Stream
#53068 MSRP \$3,399.99



Large Deluxe Pondless® Waterfall Kit
26' Stream
#53069 MSRP \$4,199.99

Comparison Chart

Model	Medium Deluxe Pondless Waterfall Kit 16' Stream	Large Deluxe Pondless Waterfall Kit 26' Stream
Waterfall Spillway	✓	✓
Vault/Basin	Pondless Waterfall Vault	Pondless Waterfall Vault
AquaBlox	(5) Small	(5) Large
Pump*	AquaSurge 2000-4000 Adjustable Flow Pond Pump	AquaSurge 4000-8000 Adjustable Flow Pond Pump
Faux Driftwood 35"	✓	✓
Pipe	Flexible PVC 2" x 25'	Flexible PVC 2" x 50'
Liner Material	45 mil EPDM (Fish Safe)	45 mil EPDM (Fish Safe)
Liner Size	10' x 12' (Reservoir) 10' x 20' (Stream)	12' x 15' (Reservoir) 10' x 30' (Stream)
Underlayment	120 ft ²	180 ft ²
Pump Check Valve Assembly	✓	✓
LED Color-Changing Lighting Package**	✓	✓
Automatic Dosing System for Fountains	✓	✓
Installation Kit***	✓	✓
Welcome Kit	✓	✓
Packaged Weight	323 lb	404 lb
Packaged Dimensions	48"L x 40"W x 24"H Palletized	48"L x 40"W x 31"H Palletized

* Options vary based on kit size.

** LED Color-Changing Lighting Package includes: Medium Kit (2) 2-Watt Color-Changing Waterfall and Up Lights, Large Kit (3) 2-Watt Color-Changing Waterfall and Up Lights, Color-Changing Lighting Control Hub, 60-Watt Transformer, 3-Way Color-Changing Splitter, 25' Color-Changing Extension Cable

*** Installation Kit includes: Silicone Sealant, EPDM Liner Patch, Pond and Waterfall Foam Sealant, Christy's Red Hot Blue Glue
Finished Pondless Waterfall size may vary based on shape and rock size.



LANDSCAPE FOUNTAIN KITS

Aquascape Landscape Fountain Kits make it easy to add a splash of water to any space in your yard, making them an ideal choice for any space. Available in a variety of options, you're sure to find one that suits your unique style.

Landscape Fountain Kits come with all the necessary components to install a recirculating fountain in just a few hours. A sub-surface basin holds the water and pump, which pushes the water up through the fountain for a stunning display. Install just one fountain, or group several together for a truly unique water feature. Just add decorative rock or mulch to complete your fountain. Then sit back and enjoy the soothing sights and sounds of running water.

Landscape Fountain Kits

The Landscape Fountain Kit

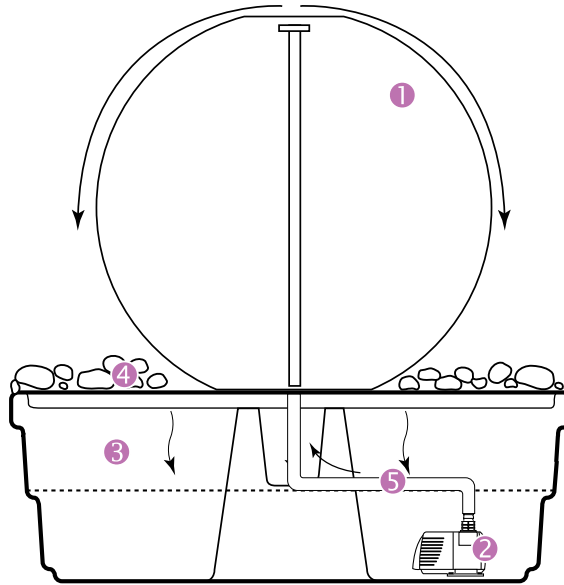

- ① Fountain
Choose from any one of the nine Aquascape fountain options
- ② Pond Pump
Pumps water from the underground reservoir through the center of the fountain
- ③ AquaBasin® 45
Provides a basin for water to be stored and protects the pump
- ④ Rocks and Gravel (not included)
Disguises the AquaBasin and naturalizes the water feature
- ⑤ Pipe
Directs water from the basin to the fountain

Landscape Fountain Kits

Aquascape Landscape Fountain Kits come complete with all the materials needed to create a beautiful focal point in any outdoor space, including an AquaBasin® 45, pipe, and the properly-sized pump. The Mongolian Basalt Columns and the Pagoda Fountain Rocks include Pond and Waterfall Foam Sealant.



Spillway Bowl and Basin
Landscape Fountain Kit

#58087 MSRP \$1,899.98

Packaged Weight: 380 lb
Packaged Dimensions: 40"L x 48"W x 66"H
Pump Included: Ultra 2000 Pond Pump
Pipe Included: Pre-Cut Kink-Free — ¾" x 12.5'



Stacked Slate Spillway Wall 32"
Landscape Fountain Kit

#78269 MSRP \$1,699.98

Packaged Weight: 157 lb
Packaged Dimensions: 40"L x 48"W x 54"H
Pump Included: Ultra 2000 Pond Pump
Pipe Included: (3) Clear Vinyl Tubing



Medium Stacked Slate Sphere
Landscape Fountain Kit

#78290 MSRP \$1,599.98

Packaged Weight: 195 lb
Packaged Dimensions: 40"L x 48"W x 46"H
Pump Included: Ultra 1500 Pond Pump
Pipe Included: Clear Vinyl Tubing



Medium Stacked Slate Urn
Landscape Fountain Kit

#58090 MSRP \$1,599.98

Packaged Weight: 180 lb
Packaged Dimensions: 40"L x 48"W x 54"H
Pump Included: Ultra 1100 Pond Pump
Pipe Included: Clear Vinyl Tubing



Medium Scalloped Urn
Landscape Fountain Kit

#78270 MSRP \$1,599.98

Packaged Weight: 145 lb
Packaged Dimensions: 40"L x 48"W x 52"H
Pump Included: Ultra 1100 Pond Pump
Pipe Included: Clear Vinyl Tubing



Medium Rippled Urn
Landscape Fountain Kit

#78271 MSRP \$1,599.98

Packaged Weight: 164 lb
Packaged Dimensions: 40"L x 48"W x 67"H
Pump Included: Ultra 1100 Pond Pump
Pipe Included: Clear Vinyl Tubing



Mongolian Basalt Column 30"
Landscape Fountain Kit

#58065 MSRP \$1,199.98

Packaged Weight: 700 lb
Packaged Dimensions: 40"L x 48"W x 31"H
Pump Included: Ultra 800 Pond Pump
Pipe Included: Pre-Cut Kink-Free — ¾" x 6'
Includes Pond and Waterfall Foam Sealant



Mongolian Basalt Columns Set
of 3 Landscape Fountain Kit

#58089 MSRP \$2,099.98

Packaged Weight: 963 lb
Packaged Dimensions: 40"L x 48"W x 31"H
Pump Included: Ultra 2000 Pond Pump
Pipe Included: Pre-Cut Kink-Free — ¾" x 15'
Includes Pond and Waterfall Foam Sealant



Pagoda Fountain Rocks Set of 3
Landscape Fountain Kit

#58086 MSRP \$1,999.98

Packaged Weight: 594 lb
Packaged Dimensions: 40"L x 48"W x 30"H
Pump Included: Ultra 2000 Pond Pump
Pipe Included: Pre-Cut Kink-Free — ¾" x 12.5'
Includes Pond and Waterfall Foam Sealant



FILTRATION

The Science Behind Filtration

There are two forms of filtration critical to maintaining a healthy ecosystem pond: mechanical and biological. Through mechanical and biological filtration, ecosystem ponds will process fish waste, uneaten fish food, leaves, and runoff from lawns.

In ecosystem ponds, mechanical filtration is provided by a pond skimmer and biological filtration is provided by a BioFalls® Filter

How to Choose the Right Filter for Your Pond

To keep your pond or water feature looking beautiful, it is important to provide proper filtration. Features and benefits of Aquascape filters are noted in the following pages, making it simple and easy to select the correct filter for your application.

New Ponds

The advantage of choosing the right filter before you get started should not be underestimated. Aquascape takes an ecosystem approach to water gardening. This approach uses a pond skimmer and BioFalls Filter. The skimmer removes leaves and debris from the surface of the pond, optimizing water quality. A BioFalls Filter performs two very important functions; it supports mechanical and biological filtration and provides a great start to any waterfall.

Existing Ponds

In some circumstances it can be challenging to add a skimmer and BioFalls to an existing system. Perhaps the shape or building technique makes it prohibitive. In this situation we recommend the use of an UltraKlean™ Pond Filter, Submersible Pond Filter, Pond Waterfall Filter, or Pond Filter Urn. These filters will retrofit quickly into existing systems and provide efficient mechanical and biological filtration.

Pond Skimmer Filters

Pond skimmers are designed to eliminate water quality problems and reduce maintenance by removing debris before it sinks to the bottom of the pond, allowing a pond to be installed anywhere, even beneath trees. Because the skimmer removes debris before it reaches the pump, it acts as a pre-filter, reducing pump maintenance and making pump access quick and easy. All pond skimmers include a limited lifetime warranty.

U.S. PATENT 7,144,501



Signature Series
200 Pond Skimmer
#43020 MSRP \$329.98



Signature Series
400 Pond Skimmer
#43021 MSRP \$499.99



Signature Series
1000 Pond Skimmer
#43022 MSRP \$749.99



Comparison Chart

Model	Signature Series 200 Pond Skimmer	Signature Series 400 Pond Skimmer	Signature Series 1000 Pond Skimmer
Pond Size	up to 200 sq. ft.	up to 400 sq. ft.	up to 1,000 sq. ft.
Pump Flow Rate	up to 3,000 GPH / 11,360 LPH	up to 4,000 GPH / 15,140 LPH	up to 10,000 GPH / 37,850 LPH*
Recommended Pumps	EcoWave and AquaSurge Pumps	EcoWave, AquaSurge, AquaSurge Adjustable Flow, and PL Pumps	EcoWave, AquaSurge, AquaSurge and SLD Adjustable Flow, and PL Pumps
Weir Size	6"	6"	8"
Adjustable Height Face Plate	–	–	✓
Locking Weir Door	–	✓	✓
Leaf & Debris Net	✓	–	–
Leaf & Debris Rigid Basket	–	✓	✓
Filter Brush Cartridge	Optional	–	–
Overflow Kit	Optional	✓	✓
Filter Mat	–	✓	✓
Faux-Rock Lid	–	✓	✓
Dimensions	22.5"L x 20"W x 18.5"H	25.75"L x 20.5"W x 25"H	25"L x 24"W x 26.75"H
Warranty	Limited Lifetime	Limited Lifetime	Limited Lifetime
Packaged Weight	14.75 lb	25 lb	34 lb
Packaged Dimensions	20"L x 17.5"W x 17.5"H	21.4"L x 18"W x 21"H	21"L x 22"W x 26.5"H

* NOTE: 12-PN 10,000 and AquascapePRO 10,000 pumps are too large to fit in these skimmers. Multiple pumps can be used to achieve up to 10,000 GPH.

Pond Skimmer Filters

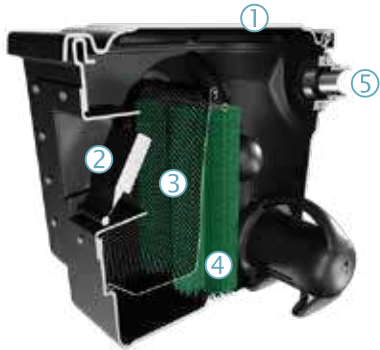

Features and Benefits of the Signature Series 200 Pond Skimmer

- ① **Custom Lid:** Durable lid provides protection of the filter components
- ② **6" Weir:** A floating weir, designed to raise and lower to match the water level in the pond
- ③ **Debris Net:** Large volume, debris net makes maintenance easier than ever
- ④ **Optional Filter Brush (#99772):** Handles any debris that finds its way past the debris net (sold separately)
- ⑤ **Optional Overflow (#88036):** Helps maintain proper water level in an overflow situation (sold separately)



Features and Benefits of the Signature Series 400 and 1000 Pond Skimmers

- ① **Faux-Rock Lid:** Natural looking faux-rock lid conceals the filter in the surrounding landscape
- ② **Patented Faceplate:** Patented adjustable faceplate allows you to adjust the water level after installation (1000 only)
- ③ **Rigid Debris Basket:** Large volume, rigid debris basket makes maintenance easier than ever
- ④ **Professional, Watertight Seals:** Injection molded fittings provide professional, watertight seals
- ⑤ **Corrosion-Resistant Hardware:** Corrosion-resistant, non-cross-threading hardware stands up to the elements
- ⑥ **Rigid Filter Mat:** Rigid filter mat effectively removes smaller sediment and debris
- ⑦ **Rounded Shape:** Rounded shape provides maximum strength
- ⑧ **Locking Weir Door:** Innovative locking weir door for ease of maintenance

Application

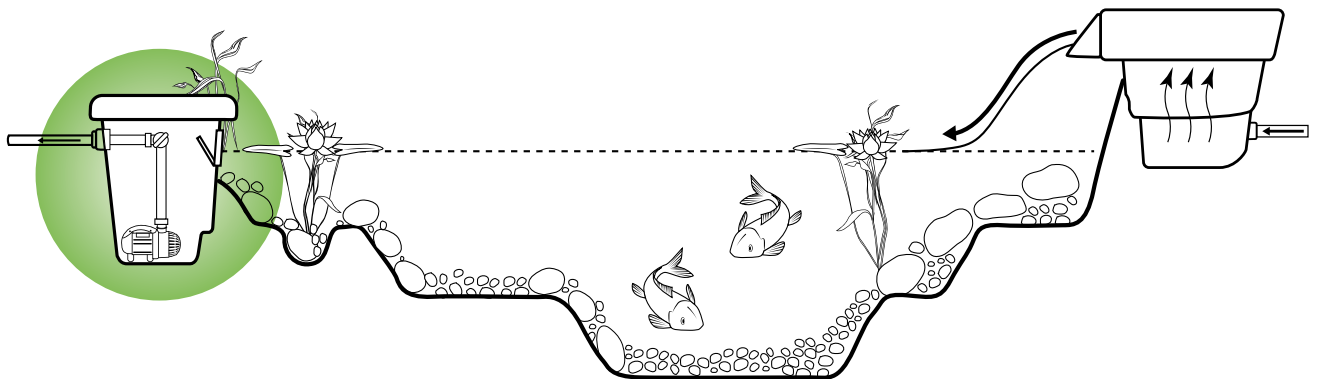

BioFalls® Filters

Aquascape Professional Grade BioFalls® Filters provide the most filtration and highest water flows in the market. Durable, rotationally-molded polyethylene construction ensures maximum strength, and all Signature Series BioFalls Filters include a limited lifetime warranty.



Signature Series 1000 BioFalls® Filter
#99774 MSRP \$429.98

Signature Series 2500 BioFalls® Filter
#09020 MSRP \$799.99

Signature Series 6000 BioFalls® Filter
 with 2" Bulkhead
#29319 MSRP \$1,199.99

Signature Series 6000 BioFalls® Filter
 with 3" Bulkhead
#29384 MSRP \$1,239.99

Comparison Chart

Model	Signature Series 1000 BioFalls Filter	Signature Series 2500 BioFalls Filter	Signature Series 6000 BioFalls Filter with 2" Bulkhead	Signature Series 6000 BioFalls Filter with 3" Bulkhead
Filters Ponds up to	1,000 gal / 3,800 L	2,500 gal / 9,500 L	6,000 gal / 22,700 L	6,000 gal / 22,700 L
Pump Flow Rate	up to 3,000 GPH / 11,400 LPH	up to 5,000 GPH / 18,900 LPH	up to 15,000 GPH / 56,800 LPH	up to 15,000 GPH / 56,800 LPH
Spillway Width	15"	21.5"	28"	28"
Bulkhead Port	Single 2"	Dual 2"	Dual 2"	Dual 3"
Fittings Included	1.5" PVC slip and 1.5" kink-free insert	Two 2" PVC slip	Two 2" PVC slip	Two 3" PVC slip
Rock Tray	Optional	✓	✓	✓
Filter Mats	Two Included	Two Included	Two Included	Two Included
BioBalls (recommended)	Holds 100*	Holds 200*	Holds 400*	Holds 400*
Filter Media Nets	One Included	Two Included	Three Included	Three Included
Dimensions	17.5"L x 20.5"W x 17"H	29.5"L x 24"W x 20"H	40"L x 45"W x 29.5"H	40"L x 45"W x 29.5"H
Warranty	Limited Lifetime	Limited Lifetime	Limited Lifetime	Limited Lifetime
Packaged Weight	11 lb	28.8 lb	55 lb	57 lb
Packaged Dimensions	18.5"L x 20.5"W x 17.5"H	30"L x 24"W x 24"H	40"L x 45"W x 29.5"H	40"L x 45"W x 29.5"H

* NOTE: BioBalls not included. See page 28.

BioFalls® Filters

Features and Benefits of the BioFalls® 1000 Filter

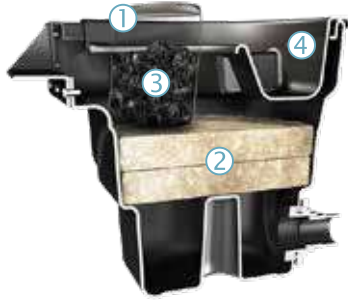

- ① Filter Media Net: BioFalls Filter Media Net (BioBalls sold separately)
- ② Biological Filter Mats: Two standard biological filter mats
- ③ Optional BioBalls Filter Media (#98464): Supports effective biological filtration by providing textured surface area for beneficial bacteria to grow and colonize (BioBalls sold separately)
- ④ Optional Rock Tray (#98285): Holds rocks, plants, and gravel, naturalizing the filter into the surrounding landscape (Rock Tray sold separately)

Features and Benefits of the BioFalls® 2500 and 6000 Filter



- ① Reversible Waterfall Lip: Reversible waterfall lip provides the option of using a natural stone spillway
- ② Removable Rock Tray: Removable rock tray holds rocks, plants, and gravel, helping to naturalize the filter into the landscape
- ③ Filter Media Net: BioFalls Filter Media Net (BioBalls sold separately)
- ④ Corrosion-Resistant Hardware: Corrosion-resistant, non-cross-threading hardware stands up to the elements
- ⑤ Biological Filter Media: Two Poly-Flo ESA biological filter mats provide 50% more surface area than traditional filter mats
- ⑥ Multiple Plumbing Options: Two bulkhead ports provide multiple plumbing options
- ⑦ Support Rack: Filter support rack ensures evenly distributed water flow through filter mats and provides structural strength to the walls of the filter
- ⑧ Circular Shape: Circular shape provides maximum strength and makes it easy to camouflage into the landscape

Application

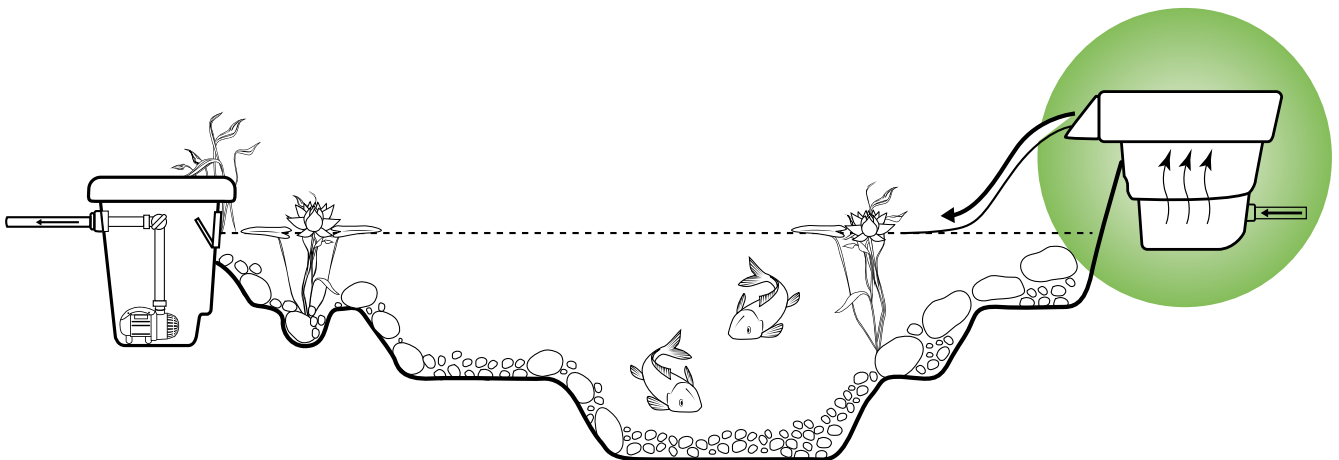

Additional Pond Filters

These filters are ideal for smaller ponds, including preformed ponds or container water gardens. These filters can be easily incorporated into existing ponds, and are ideal for use with Aquascape Ultra, EcoWave®, AquaSurge®, or AquaForce® Pumps.



Pond Waterfall Filter

#77020 MSRP \$107.98

Packaged Weight: 11 lb

- Provides efficient mechanical and biological filtration for ponds up to 1,000 gallons
- Includes rigid filter mat and biological filter media net



Features of the Pond Waterfall Filter

- ① Durable, circular construction ensures maximum strength
- ② Filter mat provides ideal mechanical and biological filtration
- ③ Included filter media net holds biological filter media (filter media sold separately)
- ④ Filter rack provides support for filter media
- ⑤ Fitting accepts 1", 1¼", and 1½" pipe sizes



Small Pond Filter Urn

#77006 MSRP \$269.98

Packaged Weight: 16.1 lb

Dimensions: 20"L x 11"W x 11"H



Features of the Pond Filter Urn

- ① Removable filter lid allows easy access for cleaning
- ② Decorative filter housing can be easily incorporated into any setting
- ③ Inlet hose accommodates most small pumps
- ④ Mechanical filtration removes debris
- ⑤ Ceramic filtration rings provide bacteria with a large surface area for colonization



Large Pond Filter Urn

#77011 MSRP \$499.98

Packaged Weight: 25 lb

Dimensions: 28"L x 15.5"W x 15.5"H

Comparison Chart

Model	Small Pond Filter Urn	Large Pond Filter Urn	Pond Waterfall Filter
Maximum Flow Rate	400 GPH	1,100 GPH	5,000 GPH
Pond Volume	500 gal	1,500 gal	1,000 gal
Inlet Fitting Dimensions	½"	¾"	1", 1.25", 1.5"
Filter Dimensions	20"L x 11"W x 11"H	28"L x 15.5"W x 15.5"H	20"L x 15"W x 12.5"H

Submersible Pond Filter

The Aquascape Submersible Pond Filter provides efficient mechanical and biological filtration. This unobtrusive filter can be added to the intake of almost any submersible water pump, resulting in crystal clear water while reducing pond pump maintenance.



Submersible Pond Filter

#95110 MSRP \$89.98

Specification Chart	
Model	Submersible Pond Filter
Pond Volume	up to 800 gal
Fitting Included	3/4", 1", 1.25"
Pr-Filtration Sponge	✓
Ceramic Filtration Rings	✓
Filter Dimensions	13"L x 11"W x 5"H
Packaged Weight	11 lb
Packaged Dimensions	12"L x 6"W x 12.75"H



Features and Benefits

- ① **Cage:** Large surface area and small openings prevents large debris from clogging the filter
- ② **Pre-Filtration Sponge:** Provides efficient mechanical and biological filtration and dramatically reduces pump maintenance
- ③ **Threaded Intake and Multi-Hose Adapters:** Included adapters make it easy to adapt to most pond pumps with a small piece of kink-free pipe or threaded fitting
- ④ **Ceramic Filtration Rings:** Provide surface area for beneficial bacteria to colonize, providing efficient biological filtration

Container Water Garden Filter

The Aquascape Container Water Garden Filter is a complete solution for container water gardens or containers with stagnant or non-moving water, including birdbaths and water containers holding pond plants like lotus or waterlilies. The magnetically-driven motor is simple and easy to maintain and extremely energy-efficient. The durable pre-filter water intake design prevents clogging and reduces pump maintenance.



Container Water Garden Filter

#77005 MSRP \$37.98

Specification Chart	
Model	Container Water Garden Filter
Container Water Garden Volume	up to 50 gal
Filter Dimensions	2"L x 1.5"W x 7"H
Packaged Weight	1 lb
Packaged Dimensions	4.25"L x 3.25"W x 8"H

BioBalls Biological Filter Media

Aquascape BioBalls provide a textured surface area (19 square inches per BioBall) for beneficial bacteria to colonize and grow, keeping pond water clean, clear, and healthy. BioBalls are easy to clean, long lasting, and lightweight, making them the ideal filtration media for use in biological filters such as BioFalls®.



BioBalls Biological Filter Media

100 Count

#98464 MSRP \$79.98

Packaged Weight: 2.25 lb

Packaged Dimensions: 8"L x 8"W x 6.5"H

- 100 BioBalls
- 1.5" diameter
- Media net included



BioBalls Biological Filter Media

1,000 Count

#56014 MSRP \$399.98

Packaged Weight: 24 lb

Packaged Dimensions: 18"L x 12"W x 14"H

- 1,000 BioBalls
- 1.5" diameter
- Media nets sold separately



BioBalls Filter Media Net

#29069 MSRP \$14.98

Packaged Weight: 0.25 lb

Packaged Dimensions: 7.25"L x 10.5"W x 1"H

Filter Rolls and Mats

Aquascape Filter Media Rolls and Rigid Filter Mats are designed to fit a wide variety of pond skimmers and filters. They can be cut to size easily using a sharp knife or pair of scissors.



Coarse Filter Media Roll

1.25" Thick

#99321 MSRP \$321.98

Packaged Weight: 8.25 lb

Product dimensions: 10'L x 56"W



Coarse Filter Media Roll

2" Thick

#99323 MSRP \$401.98

Packaged Weight: 10 lb

Product dimensions: 10'L x 56"W



Dense Filter Media Roll

1" Thick

#99325 MSRP \$267.98

Packaged Weight: 8.75 lb

Product dimensions: 10'L x 56"W



Low Density Rigid Filter Mat

#80003 MSRP \$66.98

Packaged Weight: 4.25 lb

24"L x 39"W x 1.5"Thick



Medium Density Rigid Filter Mat

#80004 MSRP \$66.98

Packaged Weight: 3.5 lb

24"L x 39"W x 1.5"Thick



High Density Rigid Filter Mat

#80005 MSRP \$73.98

Packaged Weight: 3.25 lb

24"L x 39"W x 1.5"Thick

UltraKlear® UV Clarifier

The Aquascape UltraKlear® UV Clarifier uses a technologically-advanced T5 high-output UVC bulb to eliminate green water. The Aquascape UltraKlear UV Clarifier features a swirl sleeve which directs the water around the UV bulb, maximizing contact time and increasing UV efficiency up to 50% over traditional UV clarifiers. It is simple and easy to use, install, and maintain and can be mounted horizontally or vertically.



UltraKlear® 1000 UV Clarifier
#95036 MSRP \$254.98

UltraKlear® 2500 UV Clarifier
#95037 MSRP \$321.98

UltraKlear® 5000 UV Clarifier
#95038 MSRP \$429.98

Comparison Chart

Model	UltraKlear 1000 UV Clarifier	UltraKlear 2500 UV Clarifier	UltraKlear 5000 UV Clarifier
Average Pond Size Recommendation	1,000 gal / 3,800 L	2,500 gal / 9,500 L	5,000 gal / 19,000 L
Maximum Flow Rate	500 GPH / 1,900 LPH	1,000 GPH / 3,800 LPH	1,500 GPH / 5,700 LPH
UV Wattage	14	28	55
Power Cord Length	20'	20'	20'
Discharge Hose Diameter	1", 1.25", 1.5"	1", 1.25", 1.5"	1", 1.25", 1.5"
Dimensions	23.5"L x 5.5"W x 3.75"H	33.5"L x 5.5"W x 3.75"H	43"L x 5.5"W x 3.75"H
Warranty	3-Year Limited	3-Year Limited	3-Year Limited
Packaged Weight	6.5 lb	8.75 lb	10 lb
Packaged Dimensions	24"L x 11"W x 4"H	34"L x 9.5"W x 4"H	44.5"L x 9.5"W x 4"H



Features and Benefits

- ① Narrow contact chamber increases effectiveness of UV light
- ② Internal sleeve increases contact time, thus increasing efficiency
- ③ Additional side water flow output allows for easier installation
- ④ High-output (HO) T5 bulb maximizes effectiveness
- ⑤ On/off indicator provides quick verification
- ⑥ Mounting brackets make it simple to attach the unit to a vertical surface
- ⑦ High-quality quartz sleeve maximizes bulb output
- ⑧ Mechanical safety switch automatically turns off bulb when the ballast/bulb is removed
- ⑨ Electronic ballast ensures optimum wattage and bulb output
- ⑩ Fittings included (2) 1.5" rotational ball outlet, (4) 1", 1.25", 1.5" multi-hose fittings, (2) elbows, (2) adapters, and (2) mounting brackets

UltraKlean™ Pond Filters

Aquascape UltraKlean™ Pond Filters provide optimum water quality and crystal clear pond water. The unique sponge-free design minimizes maintenance and maximizes efficient mechanical and biological filtration. The simple-to-use cleaning feature allows the unit to be backwashed in less than five minutes without opening the canister or getting hands dirty. It efficiently traps dirt and debris and integrates easily into new or existing ponds. UltraKlean Pond Filters include a high-output UV clarifier and electronic bulb-saver function that eliminates green water caused by suspended algae.



UltraKlean™ 2000 Pond Filter
#95053 MSRP \$442.98



UltraKlean™ 3500 Pond Filter
#95054 MSRP \$535.98

Comparison Chart

Model	UltraKlean 2000	UltraKlean 3500
Average Pond Size Recommendation	2,000 gal / 7,600 L	3,500 gal / 13,000 L
Maximum Flow Rate (GPH)	2,700 GPH / 10,200 LPH	5,200 GPH / 19,800 LPH
UV Wattage	14	28
Power Cord Length	20'	20'
Discharge Hose Diameter	1", 1.25", 1.5"	1", 1.25", 1.5"
Dimensions	13"L x 13"W x 17"H	13"L x 13"W x 21.5"H
Warranty	3-Year Limited	3-Year Limited
Packaged Weight	17 lb	22 lb
Packaged Dimensions	14"L x 14"W x 18"H	14"L x 14"W x 22.5"H



Features and Benefits

- ① UV clarifier/sterilizer on/off LED indicator light
- ② Cleaning indicator light signals when it's time to backwash
- ③ Electronic ballast ensures optimum wattage and bulb output
- ④ UV bulb-saver timer feature maximizes bulb life and provides an ideal time to add bacteria
- ⑤ Backwash valve and discharge shutoff valve make it easy to quickly clean the filter
- ⑥ Water inlet diffuser evenly distributes debris, maximizing mechanical filtration
- ⑦ UV clarifier/sterilizer eliminates single-celled algae commonly known as green water
- ⑧ BioBalls provide efficient biological/mechanical filtration
- ⑨ Backwash swirl diffuser efficiently churns the water to clean the filter media
- ⑩ Fittings Include: (6) 1", 1.25", 1.5" multi-hose adapters, backwash cap, (8) washers, backflush valve, and threaded adapter

UltraKlean™ Pond Filtration Kits

Aquascape UltraKlean™ Pond Filtration Kits take the guesswork out of selecting the correct pump and filtration combination for any new or existing pond. Three kit sizes are available, ensuring there is a filtration kit for almost any pond.



UltraKlean™ 1500
Pond Filtration Kit
#95058 MSRP \$799.98



UltraKlean™ 2500
Pond Filtration Kit
#95059 MSRP \$899.98



UltraKlean™ 3500
Pond Filtration Kit
#95060 MSRP \$1,149.98

Comparison Chart

Model	UltraKlean 1500 Pond Filtration Kit	UltraKlean 2500 Pond Filtration Kit	UltraKlean 3500 Pond Filtration Kit
Pond Size	up to 1,500 gal / 5,678 L	up to 2,500 gal / 9,464 L	up to 3,500 gal / 13,249 L
UltraKlean Pond Filter Size	UltraKlean 2000	UltraKlean 2000	UltraKlean 3500
UV Clarifier/Sterilizer	14-Watt	14-Watt	28-Watt
Solids-Handling Pond Pump	AquaForce 1000	AquaForce 2700	AquaForce 5200
Pipe	Kink-Free Pipe 1.5" x 25'	Kink-Free Pipe 1.5" x 25'	Kink-Free Pipe 1.5" x 25'
Stainless Steel Hose Clamps	4	4	4
2-Way Flow Control Valve	—	—	✓
Packaged Weight	39.75 lb	40 lb	48.5 lb
Packaged Dimensions	23.5"L x 21.5"W x 21"H	23.5"L x 21.5"W x 22.5"H	23.5"L x 21.5"W x 23.5"H

Application

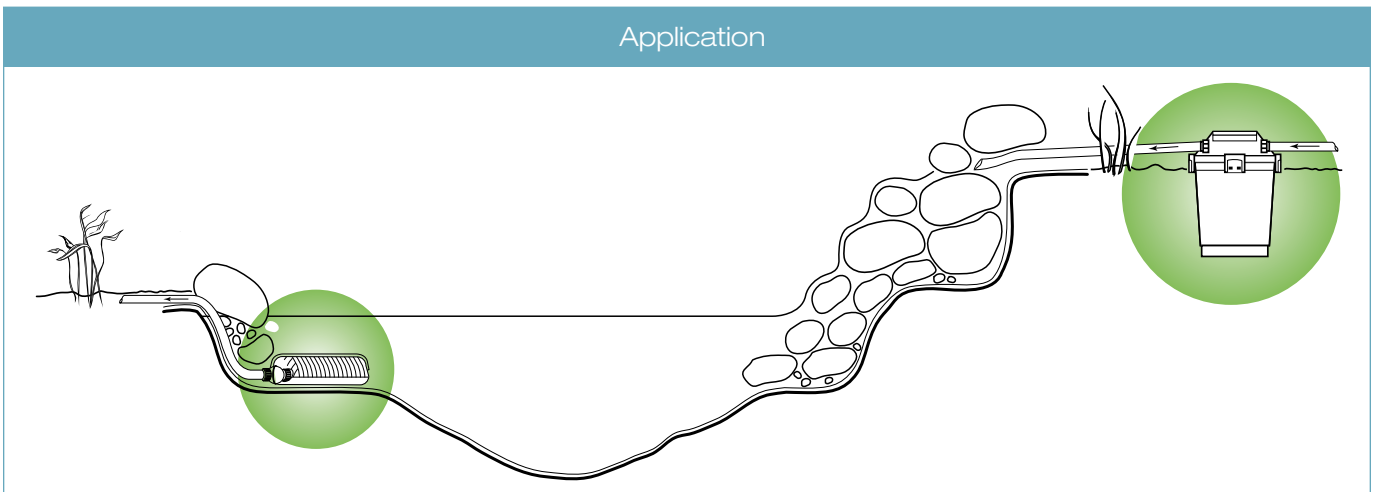

Waterfall Spillway

The Aquascape Waterfall Spillway is a cost-effective solution to create the starting point of a beautiful waterfall and stream. Use it to create a smooth, consistent, leak-free water flow. Pair multiple Waterfall Spillways together to design larger, more complex waterfall configurations. The durable design makes it easy to disguise by allowing soil, rocks, or logs to be placed directly on top of the unit. It is an excellent choice for designing additional waterfalls and streams onto new or existing ponds that already have a biological filter, or starting waterfalls on Pondless® Waterfall systems, where, due to the absence of fish, biological filters aren't necessary. The Waterfall Spillway can also be built behind hardscape walls to provide a more formal waterfall design.



Waterfall Spillway 12"
#77023 MSRP \$149.99



Waterfall Spillway 22"
#77000 MSRP \$219.99



Specification Chart		
Spillway Width	12"	22"
Bulkhead Port	Single 2"	Single 2"
Fittings Included	2" PVC slip, and 1.5" barbed hose fitting	2" PVC slip, and 1.5" barbed hose fitting
Maximum Flow Rate	4,000 GPH / 15,141 LPH	7,500 GPH / 28,000 LPH
Spillway Dimensions	10.5"L x 14"W x 5"H	17.5"L x 24"W x 5"H
Packaged Weight	4.5 lb	9 lb
Packaged Dimensions	14"L x 15"W x 5.5"H	24"L x 17"W x 5"H



Features and Benefits

- ① Durable design allows boulders, logs, or other creative landscape material to be set directly on top, helping to camouflage the spillway into the surrounding landscape
- ② Watertight connection using the fitting on the back of the Waterfall Spillway
- ③ Wide spillway opening handles high flow rates
- ④ Internal barriers provide a smooth-flowing waterfall

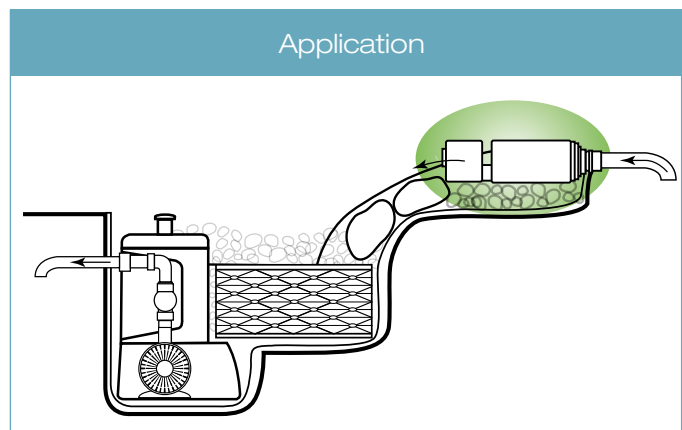

Pondless® Waterfall Vault

The Pondless® Waterfall Vault is the ideal pump vault for use in Pondless Waterfalls, rainwater harvesting systems, and large fountains, effectively protecting the pump and simplifying maintenance. It is simple to install and maintain and fits a wide range of pump sizes and flow rates. It is also perfect for use with the AquaBlox® Water Storage Modules, as Pondless Waterfall Vault Extensions can be used to extend the height for deeper applications. Both the Pondless Waterfall Vault and Extensions are made from durable rotationally-molded polyethylene. The Pondless Waterfall Vault Extensions simply slide onto the Pondless Waterfall Vault to increase its height for applications using AquaBlox Large Water Storage Modules or taller pumps.



Pondless® Waterfall Vault
#49000 MSRP \$401.99



Pondless® Waterfall Vault Extension
#49001 MSRP \$113.99

Specification Chart

Model	Pondless Waterfall Vault	Pondless Waterfall Vault Extension
Pump Flow Rates	up to 12,500 GPH / 47,300 LPH	—
Access Opening Dimensions	16"L x 16"W	16"L x 16"W
Dimensions	23"L x 17"W x 25.5"H	16"L x 16"W x 9"H
Packaged Weight	14 lb	5 lb
Packaged Dimensions	23"L x 18"W x 22.5"H	16"L x 16"W x 10"H



Features and Benefits

- ① Built-in water level inspection port allows the lid to be buried out of sight
- ② Extra wide opening provides easy pump access
- ③ Excellent water circulation through water intakes
- ④ Large interior fits a wide range of pump sizes

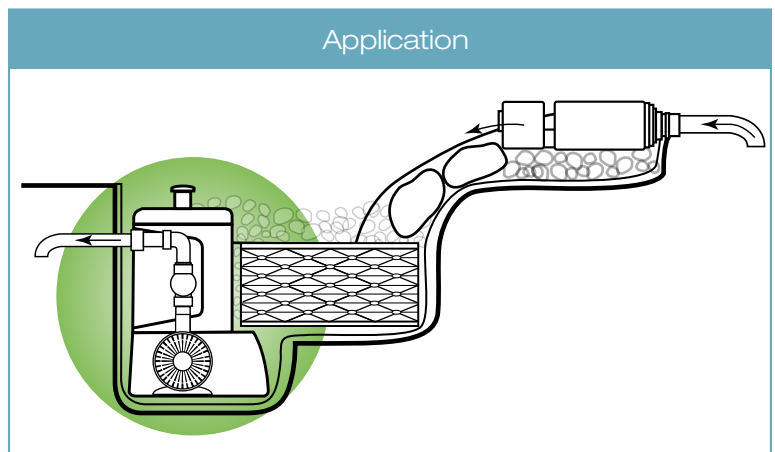

AquaBlox® Water Storage Modules

AquaBlox® Water Storage Modules provide an efficient way to maximize water storage capacity in Pondless® Waterfall reservoirs, rainwater harvesting systems, and permeable paver applications. They allow over 3 times more water storage capacity than gravel and hold approximately 7.4 gallons of water per cubic foot, compared to gravel, which holds approximately 2.2 gallons of water per cubic foot. The extra water storage capacity means less time topping off the reservoir due to evaporation and allows for a smaller reservoir footprint. It is also easier to clean and less prone to clogging than traditional gravel basins, and uses less labor to excavate and move gravel. AquaBlox also use less liner and geotextile underlayment than reservoirs constructed with gravel.



AquaBlox® Small Water Storage Module
#29491 MSRP \$57.99

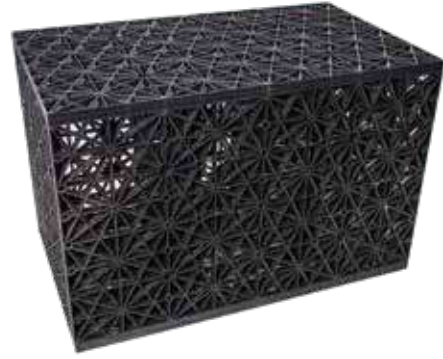

AquaBlox® Large Water Storage Module
#29492 MSRP \$71.99

Comparison Chart

Model	Small	Large
Volume	17 gal / 64.35 L	32 gal / 121.13 L
Load Bearing Weights	5,472 lb/sq. ft.	5,472 lb/sq. ft.
Dimensions	26.5"L x 16"W x 9.5"H	26.5"L x 16"W x 17.5"H
Packaged Weight	11 lb	16 lb
Packaged Dimensions	27"L x 16"W x 4"H	27"L x 16"W x 6"H

Application

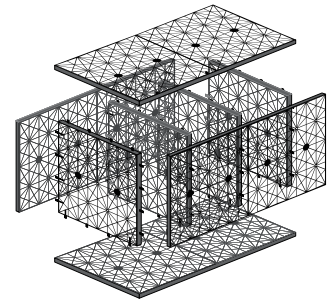
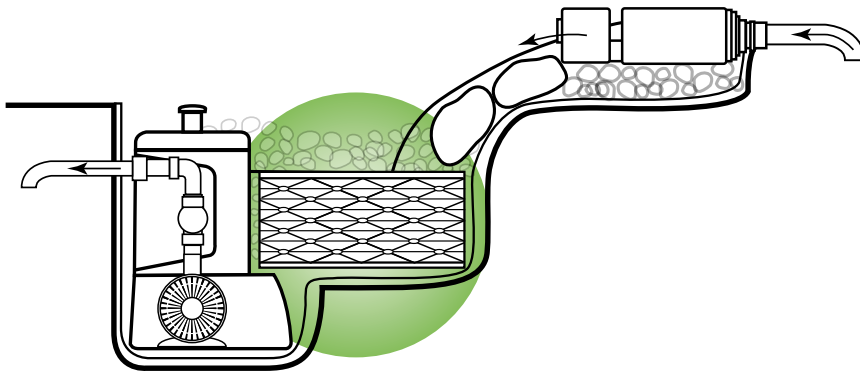

Takes one minute to assemble!

AquaBlox are assembled on-site, making transportation and installation extremely efficient

Snorkel® and Centipede® Wetland Filter

Our patented Snorkel® Vault and Centipede® Module were specifically designed to tackle the common issues that plague large scale water features. They are modular in design, allowing builders and designers the flexibility to expand the system to meet their needs. It is highly effective at removing sediment (suspended solids) from ponds, improves water clarity, and reduces the need for costly and invasive dredging. The filter system works on earth bottom and liner membrane ponds and is easily retrotitted onto existing ponds. It also reduces the physical and chemical maintenance that goes along with removing algae.



Large Snorkel® Vault and Cap

#29064 MSRP \$669.99

Packaged Weight: 27 lb



Large Snorkel® Vault Extension

#29068 MSRP \$254.99

Packaged Weight: 10 lb



Large Centipede® Module

#29065 MSRP \$469.99

Packaged Weight: 29 lb

The Wetland Filter

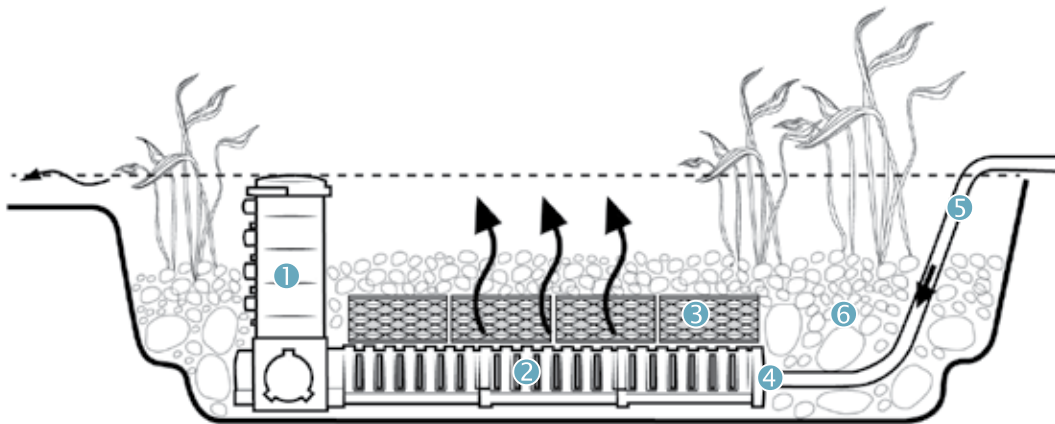

- ① **Snorkel® Vault:** Allows pump to be dropped in for easy cleaning and has four ports for Large Centipede® Module attachment (Large Snorkel Vault Extensions can be used when creating deeper basins or using the AquascapePRO® 10,000 or 12-PN pump)
- ② **Large Centipede® Module:** Sits at the lowest point in the filter and ensures maximum water distribution and allows for efficient sediment removal during cleaning
- ③ **AquaBlox®:** Provides water storage
- ④ **Rubber Coupling:** Creates a water-tight seal
- ⑤ **Flex PVC Piping:** Directs water to Centipede Module
- ⑥ **Rocks and Gravel:** Naturalizes the wetland area

Constructed Wetland Filter System Requirements

Pond Size (in sq. ft.)	Filter Size (Avg. 5.5' Depth)	Number of Centipede Modules	Number of Snorkel with Extension	Number of Small AquaBlox	Min. Pump Flow GPH
500	8' x 10'	1	1	16	2,000
1,000	10' x 15'	2	1	32	4,000
2,000	12' x 25'	4	1	64	8,000
5,000	25' x 25'	8	2	128	16,000
7,500	25' x 40'	12	2	192	24,000
10,000	25' x 50'	16	2	256	32,000
15,000	36' x 40'	18	3	288	36,000

IonGen™ System G2

The IonGen™ System G2 effectively removes debris without the use of traditional liquid chemicals. Designed with a microprocessor that sends a signal to its ion producing probe, the IonGen helps to control debris throughout the entire water feature. It is simple to install, energy-efficient, and compatible with water containing fish and plants. The IonGen is effective at treating ponds up to 25,000 gallons and comes complete with electronic control panel, outdoor-rated transformer, flow chamber, probe, probe fittings, probe holder, copper test kit, alkalinity test kit, and owner's manual



IonGen™ System G2
#95012 MSRP \$509.98

Packaged Weight: 5 lb
Packaged Dimensions: 18"L x 4.5"W x 14"H



Features and Benefits

- ① Weatherproof control panel
- ② Easy-to-read digital display
- ③ Indicator notifies you when the probe needs to be replaced
- ④ Adjustable ionization level
- ⑤ Durable quick-connect electrical connections
- ⑥ Tool-free probe installation
- ⑦ Angled probe helps deflect debris and reduce clogging
- ⑧ 2" threaded inlet and outlet
- ⑨ Fittings include: (2) 1", 1.25", 1.5" multi-hose fitting, (2) 2" PVC slip fitting

Application

- Option 1:** Probe can be installed directly into the water feature plumbing
- Option 2:** Probe can be placed in an area with good water circulation

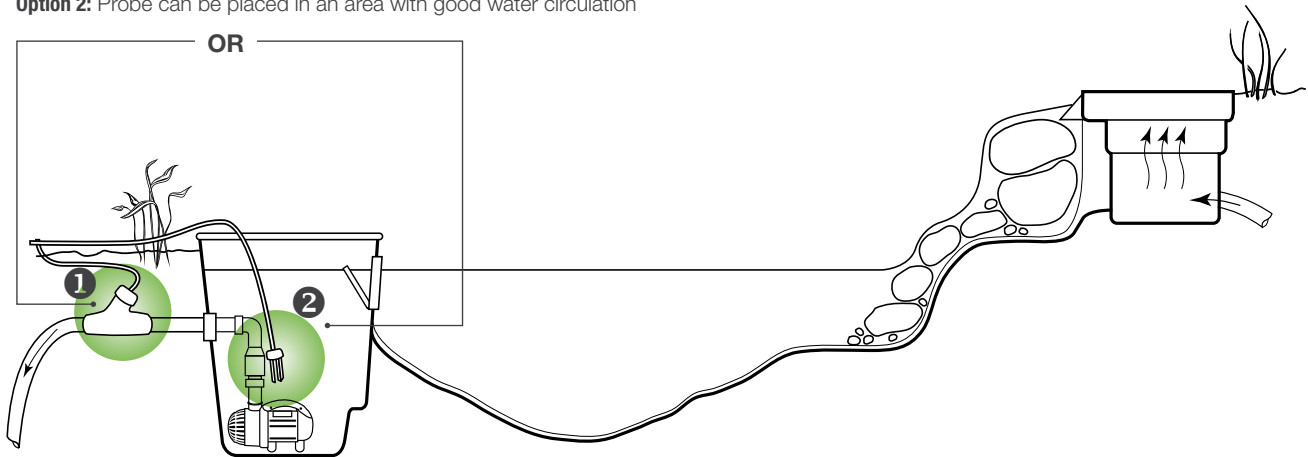

IonGen™ Accessories

The following accessories and test kits can be used in conjunction with the IonGen™ System.



IonGen™ G2 Probe Holder

#95077 MSRP \$18.98

Packaged Weight: 1.5 lb
Packaged Dimensions: N/A

- Allows for installation of G2 Probe without flow chamber
- Can be used in a filter, such as a skimmer or a Pondless® Waterfall Vault
- Straps onto any pipe or check valve from 1–4 inches in diameter



IonGen™ Probe for the G2 System

#95016 MSRP \$159.98

Packaged Weight: .5 lb
Packaged Dimensions: 3"L x 2"W x 6"H

- For 2nd generation flow chamber
- Includes 5 foot quick-connect cable



IonGen™ Probe for the G1.5 System

#95072 MSRP \$159.98

Packaged Weight: 1 lb
Packaged Dimensions: 2.75"L x 2.75"W x 4.75"H

- For 1st generation PVC tee-style flow chamber and the G2 control panel
- Include a 5 foot quick-connect cable



CU/Copper Test Kit

#96020 MSRP \$26.98

Packaged Weight: 0.2 lb
Packaged Dimensions: 4"L x 1.5"W x 5"H

- Measures residual copper
- 25 tests per kit



KH/Alkalinity Test Kit

#96019 MSRP \$26.98

Packaged Weight: 0.2 lb
Packaged Dimensions: 4"L x 1.5"W x 5"H

- Measures KH/alkalinity
- 60 tests per kit



PUMPS

Selecting the proper submersible water pump is extremely important in order to achieve optimum performance of your pond or water feature. There are three basic types of water pumps available in the water feature industry: direct-drive, asynchronous, and magnetically-driven pumps (also known as mag-drive). The following section will help you make the right selection. If you have questions about pump selection, please visit our Pond Pump Selection Guide at aquascapeinc.com/pond-pumps or contact Aquascape Customer Care.

Direct-Drive

Direct-drive water pumps provide consumers with a high torque, high head height pump option. Direct-drive pumps are generally easier to maintain because of their ability to handle larger solids. It is important to note that these pumps have to be operated within a specific performance curve to optimize lifespan.

Mag-Drive

Mag-drive water pumps are a simple and easy-to-use solution for small water features including decorative fountains and spitters. These pumps are easy to retrofit into existing water features. Mag-drive pumps have only one moving part, making them inexpensive and easy to maintain. Mag-drive pumps are also extremely quiet and energy-efficient.

Asynchronous

Asynchronous water pumps are a hybrid between a direct-drive and mag-drive pump. They have only one moving part, making them less expensive and easy to maintain. This type of pump is extremely energy-efficient, and choosing one over a traditional direct-driven pump often pays for itself quickly in power consumption savings.

Smart Control Receiver

NEW

The Aquascape Smart Control Receiver is required to run Aquascape adjustable flow pond pumps, allowing you to control your pump at anytime from anywhere. The specially designed receiver makes it easy to connect your pump to the Smart Control App on your smartphone or tablet, allowing for a variety of wireless control functions, including flow adjustment and customized scheduling.

- The Smart Control Receiver includes an integrated control panel with digital numeric display and quick and easy flow adjustment.
- Connecting your device is quick and easy, simply plug in your pump, download the Smart Control App, pair the receiver to your device, and enjoy!

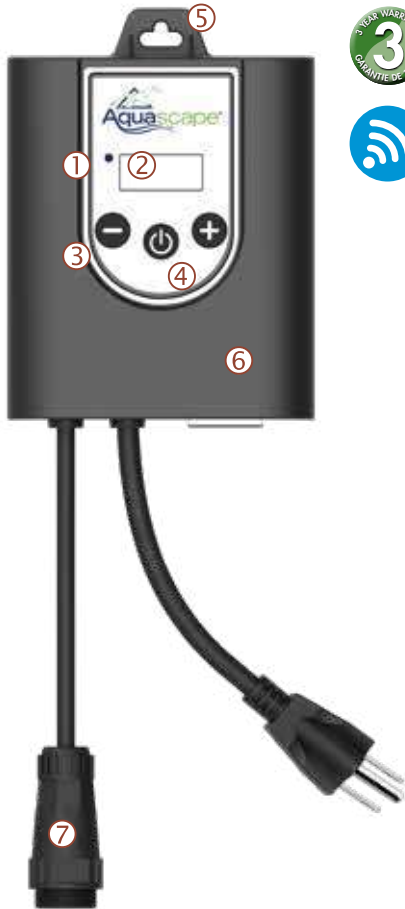

Features and Benefits

- ① WiFi pairing light indicates active connection
- ② Integrated control panel clearly displays current flow settings
- ③ Flow adjustment controls allow for quick and easy on-board flow control
- ④ On/Off controls allow the pump to be turned on or off without a remote or device
- ⑤ Integrated hang tag provides secure mounting option
- ⑥ Durable, weather-resistant, injection-molded housing is built to last
- ⑦ Integrated, weather-proof, quick-connect fitting makes setup quick and easy
- ⑧ Aquascape Smart Control App allows for a variety of wireless control functions, including flow adjustment and customized scheduling

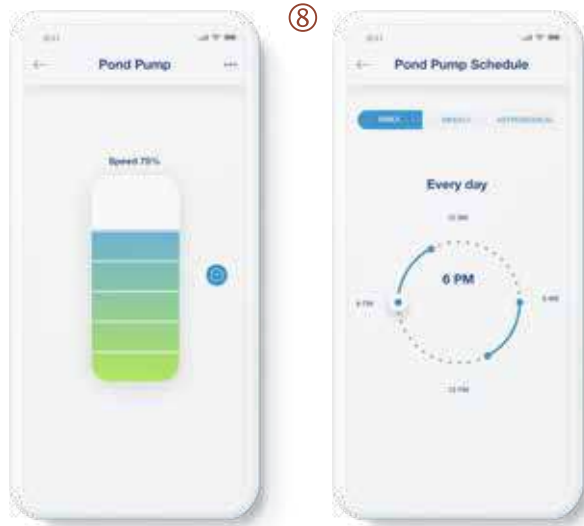

Comparison Chart

Model	SLD 4000-7000 Adjustable Flow Pump	SLD 5000-9000 Adjustable Flow Pump	AquaSurge 2000-4000 Adjustable Flow Pond Pump	AquaSurge 4000-8000 Adjustable Flow Pond Pump	AquaForce 4000-8000 Adjustable Flow Pond Pump
Smart Control Receiver	✓		✓	✓	✓
Smart Control Receiver Large		✓			
Smart Control Conversion Plug *For converting 2019 and older model adjustable flow pumps			✓	✓	✓
Universal Remote for Adjustable Flow Pumps	✓	✓	✓	✓	✓

AquaSurge® Pond Pumps

AquaSurge® Pond Pumps combine energy-efficient performance, high flow rates, and ease of maintenance, making this pump the perfect choice for pond owners. AquaSurge pumps are ideal for use in pond skimmers and Pondless® Waterfall Vaults. The asynchronous motor technology provides high torque, and trouble-free performance, while the oil-free design prevents pond contamination. Made for continuous use, the AquaSurge Pond Pumps will not corrode or rust and can be used vertically or horizontally.



AquaSurge® 2000 Pond Pump
#91017 MSRP \$469.98

AquaSurge® 4000 Pond Pump
#91019 MSRP \$619.98

AquaSurge® 3000 Pond Pump
#91018 MSRP \$539.98

AquaSurge® 5000 Pond Pump
#91020 MSRP \$689.98



AquaSurge® Low Suction Intake Attachment

#91117 MSRP \$29.98

Packaged Weight: .5 lb
Packaged Dimensions: 5.75"L x 4.5"W x 5.75"H

Allows pumps to be operated in shallow applications such as the AquaBasin® 45
NOTE: Not compatible with AquaSurge 4000-8000

AquaSurge® Adjustable Flow Pond Pumps

AquaSurge Adjustable Flow Pond Pumps include a Smart Pump Receiver which makes it easy to connect your pump to your phone or tablet, allowing for wireless flow adjustment and customized scheduling.

NEW
Now Includes Smart Control Receiver



3 YEAR WARRANTY
GUARANTEE 3 YRS



UL US

AquaSurge® 2000–4000 Adjustable Flow Pond Pump
#45009 MSRP \$849.99

AquaSurge® 4000–8000 Adjustable Flow Pond Pump
#45010 MSRP \$999.99

AquaSurge® Pond Pump Accessories

NEW



3 YEAR WARRANTY
GUARANTEE 3 YRS



Smart Control Receiver
#45038 MSRP \$229.99

Includes:

- Conversion Plug for converting older model Adjustable Flow Pumps to WiFi

NOTE: Only compatible with AquaSurge and AquaForce Adjustable Flow Pond Pumps.

Universal Remote for Adjustable Flow Pumps

#45041 MSRP \$33.99

The optional remote allows wireless control without the use of a smartphone or tablet.

NOTE: Only compatible with SLD, AquaSurge and AquaForce Adjustable Flow Pond Pumps.

AquaSurge® Pond Pumps



Features and Benefits

- ① Compact size makes it the perfect pump for pond skimmers
- ② Built-in cord strain relief protects the cord from being damaged
- ③ Asynchronous motor technology makes this pump more powerful than traditional magnetically-driven pond pumps
- ④ Unique ceramic shaft with cooling port prevents the pump from overheating
- ⑤ Simple and secure threaded disconnect allows the pump to be easily removed from the skimmer for maintenance or winterization
- ⑥ Integrated rubber feet prevent noise and vibration
- ⑦ The rotational ball output allows the discharge position to be easily adjusted
- ⑧ Included pump stand allows for vertical positioning
- ⑨ Fittings include (2) 1", 1.25", 1.5" multi-hose fittings, 1.25", 1.5", 2" multi-hose fitting, 1.5", 2" multi-hose fitting, 1.5" rotational ball output, 1.5" female coupler, 1.5" male coupler

Comparison Chart

Model	AquaSurge 2000	AquaSurge 3000	AquaSurge 4000	AquaSurge 5000	AquaSurge Adjustable Flow 2000-4000	AquaSurge Adjustable Flow 4000-8000
Maximum Flow Rate (GPH)	2,193	3,196	3,947	5,284	3,947	7,793
Adjustable Flow	—	—	—	—	✓	✓
Maximum Head Height	12.5'	15'	18.5'	24'	18.5'	28'
Motor Type	Asynchronous	Asynchronous	Asynchronous	Asynchronous	Asynchronous	Asynchronous
Wattage	160	165	215	360	180 - 215*	500 - 660*
Amperage	1.3	1.4	1.82	3	1.82	5.5
Power Cord Length	20'	20'	20'	20'	20'	20'
Pump Discharge Diameter	1.5" MPT	1.5" MPT	1.5" MPT	1.5" MPT	1.5" MPT	1.5" MPT
Acceptable Pipe Diameter	1.25", 3"	1.25", 3"	1.25", 3"	1.25", 3"	1.25", 3"	1.5"
Pump Dimensions	12"L x 5.5"W x 7"H	12"L x 5.5"W x 7"H	14"L x 6"W x 7.5"H	14"L x 6"W x 7.5"H	14"L x 6"W x 7.5"H	14"L x 6"W x 7.5"H
Remote and Receiver	—	—	—	—	✓	✓
Warranty	3-Year Limited	3-Year Limited	3-Year Limited	3-Year Limited	3-Year Limited	3-Year Limited
Packaged Weight	10 lb	10.25 lb	12.75 lb	14 lb	13 lb	16 lb
Packaged Dimensions	13.25"L x 9"W x 9"H	13.25"L x 9"W x 9.75"H	15"L x 9.25"W x 10.5"H	15"L x 9.25"W x 11.25"H	15"L x 9.5"W x 10.5"H	15"L x 9.5"W x 12"H

*Wattage range depending on flow setting.

Flow Chart

Model	Max Head Height	Application Head Height									
		0'	5'	10'	15'	20'	25'	30'	35'	40'	45'
AquaSurge 2000	12.5'	2193	1850	1465	0	GPH					
AquaSurge 3000	15'	3196	2700	2350	0	GPH					
AquaSurge 4000	18.5'	3947	3750	3350	2250	0	GPH				
AquaSurge 5000	24'	5284	5000	4750	3250	1750	0	GPH			
AquaSurge 2000-4000	18.5'	3947	3750	3350	2250	0	GPH				
AquaSurge 4000-8000	28'	7793	7350	7000	5850	4300	2000	0	GPH		

■ BEST Operating Zone ■ MAXIMUM Operating Zone

SLD Adjustable Flow Pond Pumps

NEW

Aquascape SLD Adjustable Flow Pond Pumps are professional-grade, asynchronous, solids-handling pumps ideal for use in ponds, Pondless® Waterfalls, and other water feature applications. SLD Adjustable Flow Pond Pumps provide superior reliability and solids-handling capability. The included Smart Control Receiver makes it easy to connect to the Smart Control App on your smartphone or tablet, allowing for a variety of wireless control functions, including flow adjustment and customized scheduling. The optional Universal Remote for Adjustable Flow Pumps is available separately (#45041) to allow wireless control without the use of a smartphone or tablet.

- Professional-grade, solids-handling pond pump
- Asynchronous motor design provides superior reliability with less maintenance
- Pump flow can be controlled from anywhere with your smartphone or tablet



SLD 4000-7000
Adjustable Flow Pond Pump
#45036 MSRP \$1,099.99



SLD 5000-9000
Adjustable Flow Pond Pump
#45037 MSRP \$1,299.99

SLD Adjustable Flow Pond Pumps



Feature and Benefits

- ① Smart Control Receiver connects to the Smart Control App, allowing you to control the pump with your smartphone or tablet
- ② Integrated control panel with digital numeric display and quick and easy flow adjustment
- ③ Threaded 2" outlet allows for quick and easy installation in a variety of applications
- ④ Asynchronous motor technology provides superior reliability and longevity
- ⑤ Semi-vortex impeller design maximizes water flow and reduces maintenance
- ⑥ Durable pump housing is built to last and will not corrode or rust
- ⑦ Anti-vortexing shield prevents the pump from drawing air in low-water situations
- ⑧ Rubber feet prevent noise and vibration while in use

Comparison Chart

Model	SLD 4000-7000	SLD 5000-9000
Maximum Flow Rate (GPH)	7,127	9,574
Adjustable Flow	✓	✓
Maximum Head Height	25'	33'
Motor Type	Asynchronous	Asynchronous
Wattage	660	1060
Amperage	6.6	8.9
Power Cord Length	20'	20'
Pump Discharge Diameter	2" FPT	2" FPT
Pump Dimensions	13"L x 6.25"W x 7"H	13"L x 6.25"W x 7"H
App/WIFI Connected	✓	✓
Warranty	3-Year Limited	3-Year Limited
Packaged Weight	15 lb	15 lb
Packaged Dimensions	14"L x 8"W x 9"H	14"L x 8"W x 9"H

SLD Adjustable Flow Pond Pump Flow Chart

Model	Max Head Height	Application Head Height																				
		0'	5'	10'	15'	20'	25'	30'	35'	40'	45'	50'										
SLD 4000-7000	25'	7126	6148	5044	3802	1957	GPH															
SLD 5000-9000	33'	9574	8808	7742	6412	5069	3576	1355	GPH													

BEST Operating Zone
MAXIMUM Operating Zone

PL and PN Solids-Handling Pond Pumps

The PL and PN series pumps are known for durability, performance, and value. The direct-drive motor and semi-vortex impeller design enables the pump to efficiently and effectively handle solids, resulting in less maintenance and trouble-free performance. The PL and PN pumps are ideal for use in pond skimmer filters and the Pondless® Waterfall Vault.



3-PL 3000
Solids-Handling Pond Pump
#29975 MSRP \$803.99

5-PL 5000
Solids-Handling Pond Pump
#29976 MSRP \$1,058.99

9-PL 7000
Solids-Handling Pond Pump
#29977 MSRP \$1,286.99

8-PN 5500
Solids-Handling Pond Pump
#29495 MSRP \$1,098.99

12-PN 10000
Solids-Handling Pond Pump
#30391 MSRP \$1,380.99

Comparison Chart

Model	3-PL	5-PL	9-PL	8-PN	12-PN
Maximum Flow Rate (GPH)	3,000	5,300	7,300	5,548	10,000
Maximum Head Height	14'	23'	35'	56'	23'
Motor Type	Direct Drive	Direct Drive	Direct Drive	Direct Drive	Direct Drive
Wattage	320	620	1,000	1,000	900
Amperage	3.1	5.6	8.6	9.1	9.1
Power Cord Length	20'	20'	20'	20'	20'
Pump Discharge Diameter	2"	2"	2"	2"	3"
Acceptable Pipe Diameter	3"	3"	1.5"	1.5"	2"
Pump Dimensions	12.2"L x 5.6"W x 7.1"H	13.2"L x 5.9"W x 7.3"H	14"L x 5.9"W x 7.3"H	9.3"L x 6.4"W x 15"H	11.7"L x 7.7"W x 15.1"H
Warranty	2-Year Limited	2-Year Limited	2-Year Limited	2-Year Limited	2-Year Limited
Packaged Weight	16 lb	19 lb	23 lb	24 lb	36 lb
Packaged Dimensions	13"L x 9.75"W x 9.5"H	15"L x 9.75"W x 9.5"H	15"L x 9.75"W x 9.5"H	17.25"L x 10.25"W x 9"H	12.5"L x 9"W x 17.75"H

Flow Chart

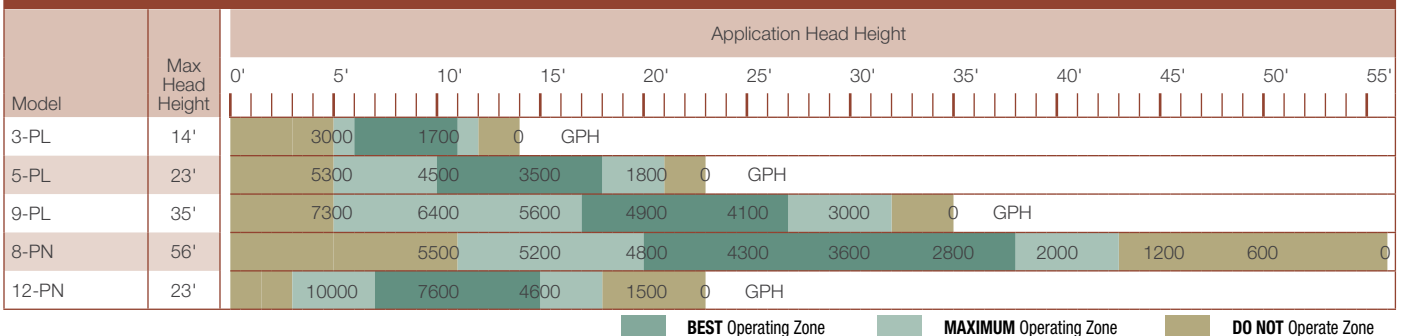

AquascapePRO® Pond Pumps

AquascapePRO® Pond Pumps are ideal for use in pond skimmer and waterfall filter systems, as well as Pondless® Waterfall Vaults. Pond pumps from the AquascapePRO line are quiet and low maintenance and feature durable, stainless steel construction along with rubber feet to reduce vibration. These pumps are ideal for high head heights.



AquascapePRO® 3000 Pond Pump

#20002 MSRP \$937.99

AquascapePRO® 4500 Pond Pump

#20003 MSRP \$1,232.99

AquascapePRO® 7500 Pond Pump

#20004 MSRP \$1,514.99

AquascapePRO® 10000 Pond Pump

#20006 MSRP \$1,768.99

Comparison Chart

Model	AquascapePRO 3000	AquascapePRO 4500	AquascapePRO 7500	AquascapePRO 10,000
Maximum Flow Rate (GPH)	2,900	4,500	6,700	10,600
Maximum Head Height	20'	33'	42'	28'
Motor Type	Direct Drive	Direct Drive	Direct Drive	Direct Drive
Wattage	280	625	1,200	1,240
Amperage	2.6	5.4	10	11
Power Cord Length	20'	20'	20'	20'
Pump Discharge Diameter	2"	2"	2"	3"
Acceptable Pipe Diameter	3"	3"	1.5"	2"
Pump Dimensions	12"L x 6"W x 7"H	13"L x 6.5"W x 7"H	13"L x 6.5"W x 7"H	12.5"L x 9"W x 17"H
Warranty	2-Year Limited	2-Year Limited	2-Year Limited	2-Year Limited
Packaged Weight	15 lb	19 lb	22 lb	40 lb
Packaged Dimensions	14.25"L x 8"W x 8"H	14.25"L x 9.25"W x 9"H	14.75"L x 9.25"W x 9"H	13.5"L x 12"W x 18.75"H

Flow Chart

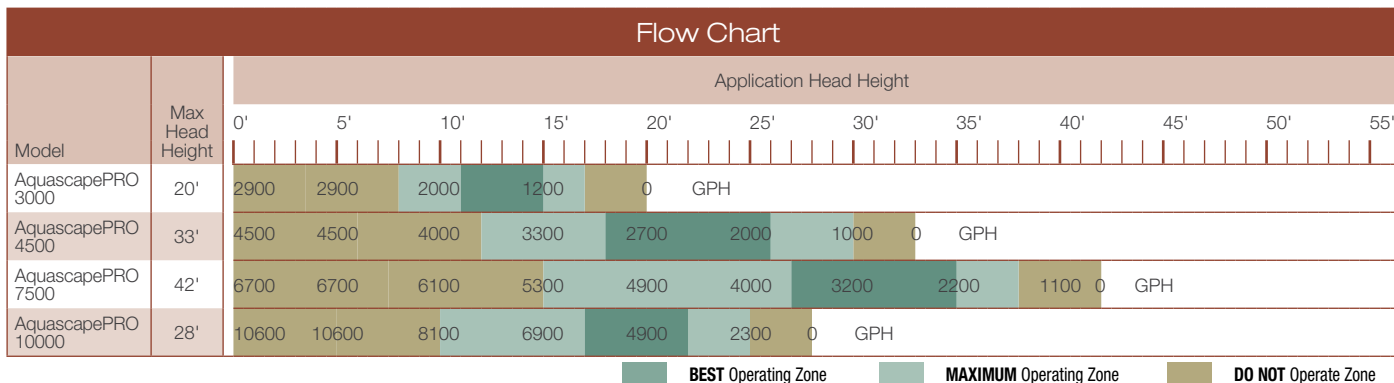

EcoWave® Pond Pumps

EcoWave® Pond Pumps are magnetically-driven (mag-drive) pond and waterfall pumps developed to provide extremely high flow rates. The internal, smart mag-drive motor technology and vortex style impeller allows these pumps to push an incredible amount of water with an electrical efficiency unmatched by other pumps with similar flow rates. EcoWave Pond Pumps are ideal for use in pond skimmers and Pondless® Waterfall Vault applications with lower head heights. Made for continuous use, the EcoWave pumps will not corrode or rust. They are complete with a compact and oil-free design that prevents pond contamination.



EcoWave® 2000 Pond Pump
#91131 MSRP \$329.98

EcoWave® 4000 Pond Pump
#91133 MSRP \$509.98

EcoWave® 3000 Pond Pump
#91132 MSRP \$369.98

EcoWave® 5000 Pond Pump
#91134 MSRP \$599.98



Features and Benefits

- ① Protective filter screen reduces maintenance and prevents damage to the pump
- ② Durable thermoplastic housing will not corrode or rust
- ③ High-flow vortex impeller maximizes water flow
- ④ Smart mag-drive motor provides significant electrical cost savings
- ⑤ Internal PC board provides high flow rates with unmatched electrical efficiency
- ⑥ Built-in overload sensor prevents pump damage
- ⑦ Rubber feet prevent noise and vibration
- ⑧ Fittings include: (2) 1", 1.25", 1.5" multi-hose fittings, 1.5" rotational ball output, 2" FPT x 1.5" MPT, 1.5" female coupler,



EcoWave® 90° Adapter
#88059 MSRP \$10.98

AquaSurge® Low Suction Intake Attachment
#91117 MSRP \$29.98

Packaged Weight: 0.15 lb
Packaged Dimensions: 4"L x 2.5"W x 3.5"H
Allows the EcoWave® to be used with the Low Suction Intake in the AquaBasin® 45.

Packaged Weight: .5 lb
Packaged Dimensions: 5.75"L x 4.5"W x 5.75"H
Allows pumps to be operated in shallow applications such as the AquaBasin® 45. Compatible with the EcoWave® 2000 & 3000

EcoWave® Pond Pumps

Comparison Chart				
Model	EcoWave 2000	EcoWave 3000	EcoWave 4000	EcoWave 5000
Maximum Flow Rate (GPH)	2,020	2,960	4,000	5,000
Maximum Head Height	14.4'	17.5'	20'	21'
Motor Type	Mag-Drive	Mag-Drive	Mag-Drive	Mag-Drive
Wattage	65	90	130	150
Amperage	0.54	.75	1.08	1.25
Power Cord Length	20'	20'	20'	20'
Pump Discharge Diameter	2" MPT	2" MPT	2" MPT	2" MPT
Acceptable Pipe Diameter	1.25"	1.25"	1.25"	1.25"
Pump Dimensions	11"L x 5.75"W x 7.5"H	11"L x 5.75"W x 7.5"H	11"L x 5.75"W x 7.5"H	11"L x 5.75"W x 7.5"H
Warranty	3-Year Limited	3-Year Limited	3-Year Limited	3-Year Limited
Packaged Weight	10.25 lb	11.5 lb	13 lb	14 lb
Packaged Dimensions	13"L x 11"W x 10.5"H	13"L x 11"W x 11.75"H	13"L x 11"W x 13"H	13"L x 11"W x 14"H

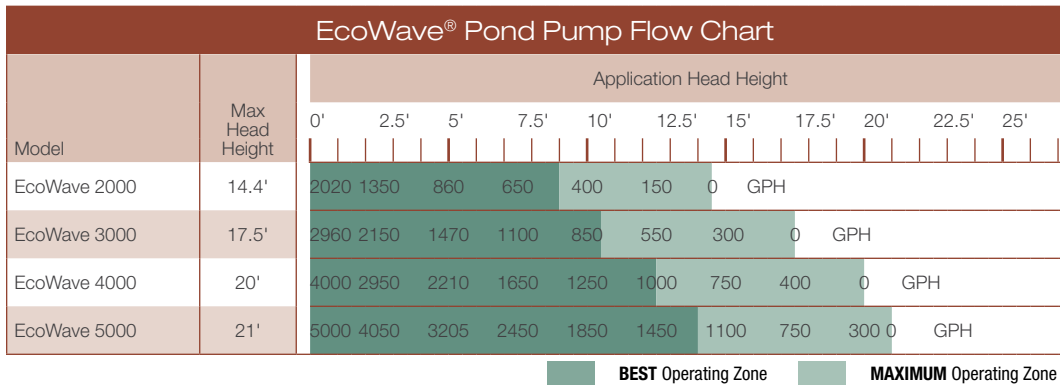

AquaForce® Solids-Handling Pond Pumps

AquaForce® asynchronous, solids-handling waterfall and filter pumps combine energy-efficient performance, high flow rates, and ease of maintenance, making this pump the ideal choice for discerning pond owners. The AquaForce protective pre-filter cage allows the pump to be placed directly into the pond. AquaForce pumps are able to pump solids up to .25" inch in diameter, making it ideal for use with external pressure filters or Aquascape waterfall filter systems. The asynchronous motor technology provides high torque, trouble-free performance and is easy to maintain. Its oil-free design prevents pond contamination. The AquaForce can be used as a de-icer pump during cold weather months.



AquaForce® 1000 Solids-Handling Pond Pump
#91011 MSRP \$269.98

AquaForce® 1800 Solids-Handling Pond Pump
#91112 MSRP \$329.98

AquaForce® 2700 Solids-Handling Pond Pump
#91012 MSRP \$369.98

AquaForce® 3600 Solids-Handling Pond Pump
#91113 MSRP \$419.98

AquaForce® 5200 Solids-Handling Pond Pump
#91013 MSRP \$539.98

AquaForce® Adjustable Flow Solids-Handling Pond Pumps

AquaForce Adjustable Flow Pond Pumps now include a Smart Control Receiver, which makes it easy to connect to the Smart Control App on your smartphone or tablet, allowing for wireless flow adjustment and customized scheduling.

NEW
Now Includes
Smart Control
Receiver



AquaForce® 4000–8000 Adjustable Flow Solids-Handling Pond Pump
#91104 MSRP \$999.99

AquaForce® Pond Pump Accessories



Smart Control Receiver
#45038 MSRP \$229.99

Includes:

- Conversion Plug for converting older model Adjustable Flow Pumps to WiFi

NOTE: Only compatible with AquaSurge and AquaForce Adjustable Flow Pond Pumps.

Universal Remote for Adjustable Flow Pumps
#45041 MSRP \$33.99

The optional remote allows wireless control without the use of a smartphone or tablet.

NOTE: Only compatible with SLD, AquaSurge and AquaForce Adjustable Flow Pond Pumps.

AquaForce® Solids-Handling Pond Pumps



Feature and Benefits

- ① Protective pump cage prevents large debris from clogging or damaging pump, reducing maintenance
- ② Large cage openings allow solids to be easily passed and filtered, preventing the pump from being clogged or damaged
- ③ Asynchronous motor technology makes this pump more powerful than traditional magnetically-driven pond pumps
- ④ The simple and secure threaded disconnect allows the pump to be easily removed from the pond for maintenance or winterization without removing hose clamps or plumbing assembly
- ⑤ The wide, flat shape of the pump cage makes it stable and easy to place in the pond
- ⑥ The rotational ball output allows the pump discharge position to be easily adjusted, making this pump ideal for all shapes and sizes of ponds
- ⑦ Fittings include (2) 1", 1.25", 1.5" multi-hose fittings, 1.25", 1.5", 2" multi-hose fitting, 1.5", 2" multi-hose fitting, 1.5" rotational ball output, 1.5" female coupler, 1.5" male coupler

Comparison Chart

Model	AquaForce 1000	AquaForce 1800	AquaForce 2700	AquaForce 3600	AquaForce 5200	AquaForce Adjustable Flow 4000-8000
Maximum Flow Rate (GPH)	1,070	2,149	2,695	3,868	5,284	7,793
Adjustable Flow	—	—	—	—	—	✓
Maximum Head Height	10'	16.5'	14'	18'	24'	28'
Motor Type	Asynchronous	Asynchronous	Asynchronous	Asynchronous	Asynchronous	Asynchronous
Wattage	55	160	147	215	360	500-660*
Amperage	0.51	1.33	1.25	1.8	3	5.5
Power Cord Length	25'	25'	25'	25'	25'	20'
Pump Discharge Diameter	1.5" MPT	1.5" MPT	1.5" MPT	1.5" MPT	1.5" MPT	1.5" MPT
Acceptable Pipe Diameter	1", 3"	1", 3"	1", 3"	1", 3"	1", 3"	1.5"
Dimensions Pump	14"L x 14"W x 6.5"H	14"L x 14"W x 6.5"H	14"L x 14"W x 6.5"H	14"L x 14"W x 6.5"H	14"L x 14"W x 6.5"H	14"L x 14"W x 6.5"H
Remote and Receiver	—	—	—	—	—	✓
Warranty	3-Year Limited	3-Year Limited	3-Year Limited	3-Year Limited	3-Year Limited	3-Year Limited
Packaged Weight	11 lb	12.25 lb	12 lb	14.5 lb	14.5 lb	18.5 lb
Packaged Dimensions	14.25"L x 9"W x 14.75"H	14.25"L x 9"W x 15.25"H	14.25"L x 9"W x 15.75"H	14"L x 9"W x 16.25"H	14"L x 9"W x 16.75"H	14"L x 9"W x 18.75"H

* Wattage range depending on flow setting.

AquaForce® and AquaForce® Adjustable Flow Pond Pump Flow Chart

Model	Max Head Height	Application Head Height												
		0'	5'	10'	15'	20'	25'	30'	35'	40'	45'	50'	55'	
AquaForce 1000	10'	1070	850	0	GPH									
AquaForce 1800	16.5'	2149	1806	1320	260	0	GPH							
AquaForce 2700	14'	2695	2425	1840	0	GPH								
AquaForce 3600	18'	3868	3613	3254	2100	0	GPH							
AquaForce 5200	24'	5284	5116	4250	3186	1500	0	GPH						
AquaForce 4000-8000	28'	7794	7150	6440	5320	3950	1800	0	GPH					

BEST Operating Zone MAXIMUM Operating Zone

AquaJet® Pond Pumps

AquaJet® Pond Pumps create a stunning water fountain with the choice of three included fountain heads and an integrated diverter valve to supply water to a small waterfall, external filters, or spitting ornaments. These mag-drive pumps are extremely energy-efficient, resulting in considerable annual energy savings. They're easy to maintain and include a durable pre-filter cage design that prevents clogging and reduces pump maintenance.

AquaJet® 600 Pond Pump

#91014 MSRP \$289.98

AquaJet® 1300 Pond Pump

#91015 MSRP \$329.98

AquaJet® 2000 Pond Pump

#91016 MSRP \$429.98



Features of the AquaJet® Pond Pumps

- ① Adjustable riser stem allows for easy height adjustment from 10 to 20 inches
- ② Adjustable diverter and flow control
- ③ Rotational riser stem fitting allows for simple leveling of fountain heads
- ④ Protective pump cage prevents debris from clogging or damaging pump, thereby reducing maintenance
- ⑤ Mag-drive motor technology makes this pump energy-efficient and simple to maintain
- ⑥ Fine cage openings prevents fountain heads from becoming clogged
- ⑦ Pump cage clips make it easy to perform pump maintenance or remove debris
- ⑧ Fittings include AquaJet riser stems, multi-hose fitting, diverter valve, and foaming jet, waterbell, and daisy fountain heads



Comparison Chart

Model	AquaJet 600	AquaJet 1300	AquaJet 2000
Pond Size Recommendation	1,200 gal	1,300 gal	2,000 gal
Maximum Fountain Height (Daisy Fountain)	up to 47"	up to 62"	up to 65"
Motor Type	Mag-drive	Mag-drive	Mag-drive
Wattage	33	110	250
Amperage	0.55	1.00	2.60
Power Cord Length	25'	25'	25'
Pump Discharge Diameter on Diverter	1/2", 3/4"	1/2", 3/4"	1/2", 3/4", 1"
Dimensions	12"L x 12"W x 6"H	12"L x 12"W x 6"H	12"L x 12"W x 6"H
Warranty	3-Year Limited	3-Year Limited	3-Year Limited
Packaged Weight	6.5 lb	9 lb	9.5 lb
Packaged Dimensions	13"L x 9"W x 14"H	13.25"L x 8.75"W x 15"H	13.25"L x 9"W x 15.75"H

Flow Chart

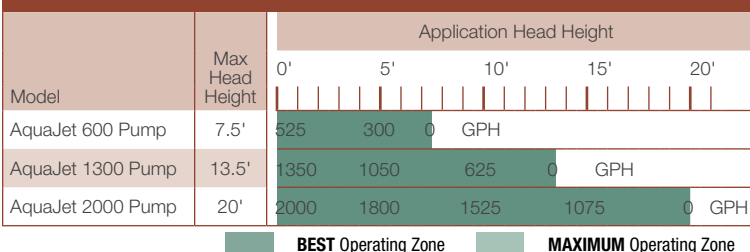

Pond Powerhead

The Aquascape Pond Powerhead is an innovative low voltage circulation pump designed to create water movement in ponds. Either set the powerhead directly in the pond or disguise it using rocks or other materials. Great for solving problems with stagnant water, the Pond Powerhead provides water movement, surface agitation, aeration, and circulation. Its small compact design makes it easy to install in a new or existing water feature and requires no pipe or plumbing. The energy-efficient, low voltage 40-Watt motor can be powered by a standard outdoor 12-volt low voltage transformer (sold separately, see page 74). It includes 25 feet quick-connect cable and can be used alone or with additional Pond Powerheads to maximize circulation in larger water features.



Features of the Pond Powerhead

- ① Adjustable head allows for directional flow control
- ② Propeller provides maximum water flow
- ③ Energy-efficient, 12-volt motor design
- ④ Durable construction ensures years of trouble-free use

Pond Powerhead

#91142 MSRP \$219.98

Packaged Weight: 7.75 lb

Dimensions: 9.75"L x 5.75"W x 5.75"H

Wiring Diagram

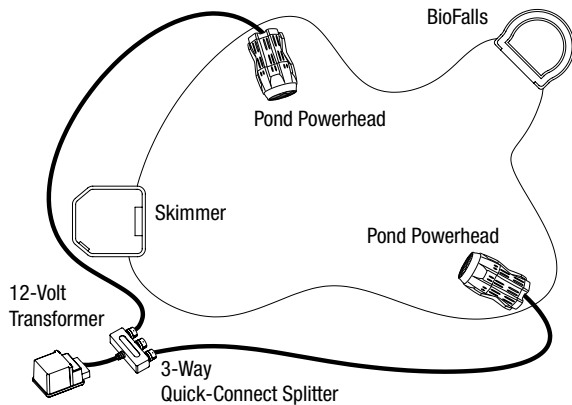

Compatible with Aquascape quick-connect splitters and extension cables (see page 66)

Application

Typical Application

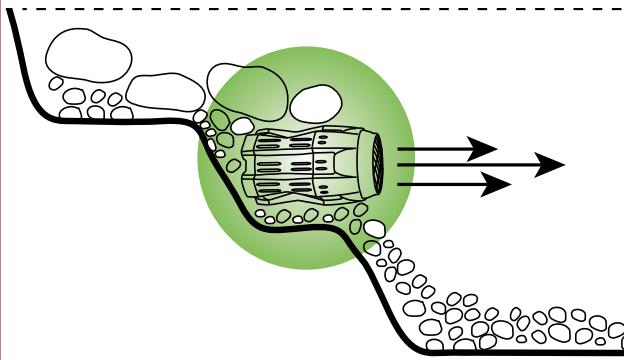

Winter Application

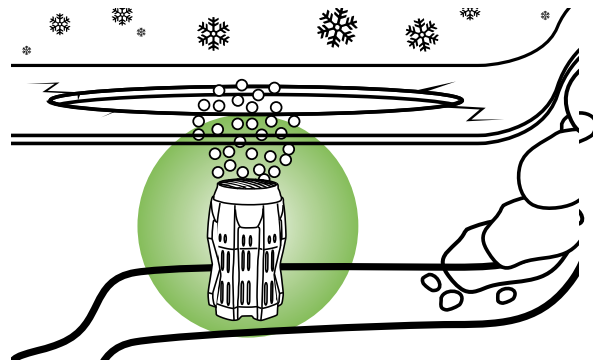

Ultra Water Pumps

Ultra Water Pumps are the complete solution for decorative fountains and spitters. These versatile pumps include a three-way or single valve and multi-size hose connection, making them adaptable to almost any pipe or tubing size. The magnetically-driven motor technology is easy to maintain and extremely energy-efficient, saving hundreds of dollars over traditional water pumps. The durable pre-filter cage design protects pump and reduces pump maintenance, and its oil-free design prevents contamination.



Ultra 400 Water Pump
#91005 MSRP \$113.98

Ultra 800 Water Pump
#91007 MSRP \$174.98

Ultra 1500 Water Pump
#91009 MSRP \$281.98

Ultra 550 Water Pump
#91006 MSRP \$140.98

Ultra 1100 Water Pump
#91008 MSRP \$254.98

Ultra 2000 Water Pump
#91010 MSRP \$321.98

Ultra Water Pump Fountain Head Kits



Small Ultra Pump Fountain Head Kit

Ideal for Ultra 400, 550, and 800

#91045 MSRP \$22.98

Packaged Weight: .5 lb

Packaged Dimensions: 5.5"L x 3.5"W x 7.25"H



Large Ultra Pump Fountain Head Kit

Ideal for Ultra 1100, 1500, and 2000

#91046 MSRP \$29.98

Packaged Weight: .5 lb

Packaged Dimensions: 6"L x 3"W x 9"H



①



②



③

Included Fountain Heads

- ① Foaming Jet Fountain
- ② Daisy Fountain
- ③ Waterbell Fountain

Ultra Water Pumps



Features of the Ultra Water Pumps

- ① Protective pump strainer cover and sponge filter prevent debris from damaging pump, thereby reducing maintenance and prolonging pump life
- ② Mag-drive motor technology makes this pump energy-efficient and simple to maintain
- ③ The wide, flat base and rubber feet make the pump stable and reduce vibration
- ④ Fittings included with the Ultra 400, 550, and 800: ¾", 1", 1.25" multi-hose adapter, ½" MPT coupling, FPT 90° elbow ½", ½" valve
- ⑤ Fittings included with the Ultra 1100, 1500, and 2000: ¾", 1", 1.25" multi-hose adapter, 1", 1.25", 1.5" multi-hose adapter, ¾" MPT coupling, FPT 90° elbow ¾", ¾" 3-way valve



Comparison Chart

Model	400	550	800	1100	1500	2000
Maximum Flow Rate (GPH)	370	528	793	1,110	1,480	1,982
Maximum Head Height	7.5'	8'	9'	12'	16.5'	20'
Motor Type	Mag-drive	Mag-drive	Mag-drive	Mag-drive	Mag-drive	Mag-drive
Wattage	24	33	58	92	153	250
Amperage	0.40	0.55	0.80	0.85	1.46	2.60
Power Cord Length	12'	12'	25'	25'	25'	25'
Pump Discharge Diameter	½", ¾", 1", 1.25"	½", ¾", 1", 1.25"	½", ¾", 1", 1.25"	¾", 1", 1.25"	¾", 1", 1.25"	¾", 1", 1.25"
Acceptable Pipe Diameter	1.25"	1.25"	1.25"	½", 1.5"	½", 1.5"	½", 1.5"
Pump Dimensions	5.5"L x 4"W x 3.5"H	6"L x 4"W x 4"H	6"L x 4"W x 4"H	9"L x 5"W x 6"H	9.5"L x 6"W x 7"H	9.5"L x 6"W x 7"H
Warranty	3-Year Limited	3-Year Limited	3-Year Limited	3-Year Limited	3-Year Limited	3-Year Limited
Packaged Weight	2.5 lb	3lb	4.5 lb	5.25 lb	8 lb	9 lb
Packaged Dimensions	9"L x 5"W x 5"H	9"L x 5.25"W x 5.25"H	9"L x 6.5"W x 6"H	9.5"L x 6.75"W x 7"H	10.5"L x 8"W x 8"H	10.5"L x 8"W x 9"H

Flow Chart

Model	Max Head Height	Application Head Height										
		0'	2.5'	5'	7.5'	10'	12.5'	15'	17.5'	20'	22.5'	25'
Ultra 400	7.5'	370	300	200	0	GPH						
Ultra 550	8'	528	425	300	75	0	GPH					
Ultra 800	9'	793	675	500	275	0	GPH					
Ultra 1100	12'	1110	1000	800	600	300	0	GPH				
Ultra 1500	16.5'	1480	1350	1200	1050	825	575	200	0	GPH		
Ultra 2000	20'	1985	1875	1750	1600	1375	1125	800	450	0	GPH	

BEST Operating Zone

Statuary Water Pumps

These high quality, magnetically-driven water pumps are ideal for supplying water to run small fountains, container water gardens, and decorative spitters. The combination of energy efficiency, mag-drive performance, water flow, and ease of maintenance makes this pump the ideal choice for discerning water feature owners. The durable pre-filter cage design prevents clogging and reduces pump maintenance, while the oil-free design prevents contamination.



70 GPH Water Pump
#91023 MSRP \$20.98

180 GPH Water Pump
#91025 MSRP \$37.98

90 GPH Water Pump
#91024 MSRP \$24.98

320 GPH Water Pump
#91026 MSRP \$50.98



Features of the Statuary Pumps

- ① Mag-drive motor technology makes this pump energy-efficient and simple to maintain
- ② Included flow control allows you to create a customized water flow
- ③ The wide, flat base of the pump makes it stable and easy to place in the pond or fountain
- ④ Protective pump input strainer cover prevents debris from clogging or damaging pump, reducing maintenance
- ⑤ Intake strainer on the bottom of the pump prevents the pump from running dry or pulling in air in shallow applications

Comparison Chart

Model	70 GPH	90 GPH	180 GPH	320 GPH
Maximum Flow Rate (GPH)	70	90	180	320
Maximum Head Height	2'	3'	4'	5.5'
Motor Type	Mag-drive	Mag-drive	Mag-drive	Mag-drive
Wattage	3.0	4.3	9.3	17.6
Amperage	0.037	0.061	0.175	0.339
Power Cord Length	6'	6'	6'	6'
Discharge Hose Diameter	½", ⅝"	½", ⅝"	½", ⅝"	½", ⅝"
Pump Dimensions	2"L x 1.5"W x 1.25"H	2.5"L x 1.75"W x 2"H	3"L x 2.5"W x 2"H	4"L x 3.25"W x 2.5"H
Warranty	3-Year Limited	3-Year Limited	3-Year Limited	3-Year Limited
Packaged Weight	.75 lb	.75 lb	1.5 lb	1.25 lb
Packaged Dimensions	4"L x 4"W x 2.75"H	4.25"L x 4"W x 3.25"H	4"L x 4"W x 4"H	4"L x 4"W x 4.75"H

Cleanout Pump and Discharge Hose

The Aquascape Cleanout Pump is great for pond cleanouts and installation wash-downs. The Cleanout Pump can handle 4,200 gallons an hour for quick, easy pump-outs. It can pump water down to a quarter inch off the bottom of the pond. The heavy-duty Cleanout Pump Discharge Hose is engineered for flexibility and optimal flow. The swivel cuff fitting prevents kinking or tangling for easy movement around the water feature.



Cleanout Pump

#45033 MSRP \$669.99

Packaged Weight: 26 lb

Packaged Dimensions: 10"L x 8.25"W x 14"H



Cleanout Pump Discharge Hose 50'

#48019 MSRP \$134.99

Packaged Weight: 14.75 lb

Packaged Dimensions: 22.5"L x 22.5"W x 9"H

Pump Cleaner Maintenance Solution

The Aquascape Pump Cleaner Maintenance Solution quickly cleans pond, waterfall, and fountain pumps to keep them operating properly. This maintenance solution uses cutting-edge cleaning compounds to remove scale and bio-film to restore the pump.



Pump Cleaner Maintenance Solution — 8 oz

#91143 MSRP \$26.98

Packaged Weight: .75 lb





AERATION

Every biological process that occurs in ponds is dependent on oxygen. This is especially important in warmer temperatures or at night when plants are not converting sunlight into oxygen. Pond aerators supply dissolved oxygen directly to ponds and other water features, helping all biological processes and resulting in healthier fish and plants. Proper aeration creates a stable pond environment, keeping water healthy, clean, and clear. Aeration can also be used during cold winter months to keep a hole open in the ice formed at the surface of the pond, allowing for necessary de-gassing.

Aquascape provides a complete line of pond aeration supplies that are available as complete kits or individual components, including compressors, diffusers, weighted tubing, and more. The specification chart and following information will help you to make the right product selection.

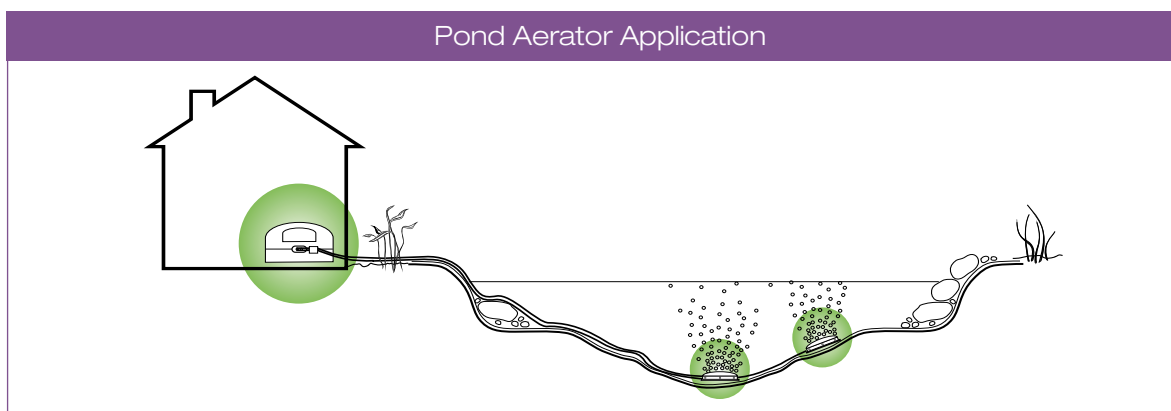

2-Outlet and 4-Outlet Pond Aeration Kits

Aquascape 2-Outlet and 4-Outlet Pond Aeration Kits provide efficient aeration for ponds and water features up to 3,500 gallons, resulting in a healthier ecosystem and happier fish and plants. These aerators are extremely energy-efficient and operate quietly. They are simple to use and easy to maintain. The durable outer housing prevents damage, and the kits include a winter resistant air line, preassembled check valves, and air discs.



2-Outlet Pond Aeration Kit
#75000 MSRP \$89.98



4-Outlet Pond Aeration Kit
#75001 MSRP \$159.98



Pond Aerator Aeration Disc
#75005 MSRP \$12.98
Packaged Weight: .5 lb
Packaged Dimensions: 5"L x 9"W x 1"H



4-Outlet Pond Aeration Kit Shown

Features and Benefits

- ① Strong outer housing protects the pump from becoming damaged
- ② A thick rubber gasket reduces noise and prevents vibration
- ③ The wide, flat base of the pump makes it stable and easy to place
- ④ The integrated rubber feet minimize noise and vibration while maximizing stability

Comparison Chart

Model	2-Outlet Pond Aeration Kit	4-Outlet Pond Aeration Kit
Pond Size	Up to 2,000 gal	Up to 3,000 gal
Maximum Recommended Pond Depth	8.5'	9'
Maximum Air Flow Rate (Loaded)	0.28 CFM (8 L/min)	0.49 CFM (14 L/min)
Maximum Air Depth (Loaded)	3.70 psi (0.26 kgf/cm ²)	3.98 psi (0.28 kgf/cm ²)
Number of Outlets	2	4
Number of Aeration Discs	2	4
Wattage	6	11
Power Cord Length	6'	6'
Airline Length	(2) 25' Rolls 3/16" Silicone	(4) 25' Rolls 3/16" Silicone
Pump Dimensions	5.25"L x 4.75"W x 3.5"H	7.75"L x 7.25"W x 6.25"H
Aeration Disc Diffuser Dimensions	4" diameter	4" diameter
Check Valve (Included and Pre-Installed)	✓	✓
Warranty	3-Year Limited	3-Year Limited
Packaged Weight	3.5 lb	6.25 lb
Packaged Dimensions	15.5"L x 4"W x 12"H	17.75"L x 5.5"W x 11.75"H

Pro Air Pond Aeration Kits



Pro Air 20 Pond Aeration Kit
#61009 MSRP \$209.99



Pro Air 60 Pond Aeration Kit
#61008 MSRP \$409.99



Features and Benefits

- ① Outdoor-rated compressor with heavy-duty metal housing stands up to the elements
- ② 2-Way Compressor Manifold allows for easy airflow adjustment
- ③ Integrated rubber feet minimize noise and vibration
- ④ 3/8" braided tubing with pre-installed check valve is freeze resistant and built to last
- ⑤ Interior weighted ballast keeps the diffuser at the bottom of the pond
- ⑥ Self-cleaning rubber membrane expands to clear clogging debris

Comparison Chart

Model	Pro Air 20 Pond Aeration Kit	Pro Air 60 Pond Aeration Kit	Pro Air 20 Aeration Compressor	Pro Air 60 Aeration Compressor
Pond Size	Up to 5,000 gal	Up to 15,000 gal	Up to 5,000 gal	Up to 15,000 gal
Maximum Recommended Pond Depth	6.5'	11.5'	6.5'	11.5'
Maximum Air Flow Rate (Loaded)	0.71 CFM (20 L/min)	2.1 CFM (60 L/min)	0.71 CFM (20 L/min)	2.1 CFM (60 L/min)
Maximum Air Depth (Loaded)	2.90 psi (0.20 kgf/cm ²)	5.08 psi (0.36 kgf/cm ²)	2.90 psi (0.20 kgf/cm ²)	5.08 psi (0.36 kgf/cm ²)
Number of Outlets	1	2	1	2
Number of Aeration Discs	1	2	—	—
Wattage	15	45	15	45
Power Cord Length	6'	6'	6'	6'
Airline Length	(1) 30' Roll 3/8" Braided Vinyl	(2) 30' Roll 3/8" Braided Vinyl	—	—
Pump Dimensions	6"L x 5.5"W x 4.25"H	7.75"L x 7.25"W x 4"H	6"L x 5.5"W x 4.25"H	7.75"L x 7.25"W x 4"H
Aeration Diffuser Dimensions	10"L x	10"L x	—	—
Check Valve (Included and Pre-Installed)	✓	✓	✓	✓
Warranty	3-Year Limited	3-Year Limited	3-Year Limited	3-Year Limited
Packaged Weight	11.5 lb	22 lb	5.75 lb	11.5 lb
Packaged Dimensions	12"L x 11"W x 10"H	14.25"L x 12.75"W x 9"H	8.75"L x 7.5"W x 7"H	9.5"L x 7.75"W x 8.25"H

Pro Air Pond Aeration Accessories



Pro Air 20 Aeration Compressor
#61017 MSRP \$139.99



Pro Air 60 Aeration Compressor
#61016 MSRP \$269.99



Weighted Aeration Tubing
3/8" x 25'
#61011 MSRP \$39.99
Packaged Weight: 5.5 lb



Weighted Aeration Tubing
3/8" x 100'
#61014 MSRP \$133.99
Packaged Weight: 23 lb



10" Rubber Membrane
Aeration Diffuser
#61010 MSRP \$46.99
Packaged Weight: 2.75 lb



2-Way Aeration
Compressor Manifold
#61012 MSRP \$18.99
Packaged Weight: 0.25 lb
NOTE: Only for use with Pro Air 60 Aeration Compressor



Barbed Coupling 3/8"
#99159 MSRP \$6.99
Packaged Weight: 0.25 lb



LIGHTING

Add a new dimension to your water feature by bringing it to life at night. With today's busy lifestyle, it's important to be able to enjoy your pond or landscape at any time of the day. The complete line of Aquascape lighting makes enjoying your garden easy — day or night.

Aquascape LED lighting combines style and simplicity. Our component fixtures include a die-cast metal housing finished with a protective coating, providing a durable finish that will hold up in all weather conditions. Aquascape LED lighting can be used fully submersed or in traditional landscapes. Aquascape LED lights feature permanently sealed watertight fixtures and are backed by a limited full replacement warranty.

Garden and Pond LED Spotlight Kit

The Aquascape Garden and Pond LED Spotlight Kit is perfect for highlighting fountains, lighting up container water gardens, or accenting your ecosystem pond. The natural warm white of the three pre-wired 1-Watt LED lights give a warm glow to your water feature. The 12-volt quick-connect components integrate easily with other Aquascape lights, and are simple and easy to install. The Garden and Pond LED Spotlight Kit include three pre-wired 1-Watt LED lights, one 6-Watt 12V Quick-Connect Transformer, and one automatic on/off Photocell with Digital Timer.



Garden and Pond LED Spotlight Kit

#84030 MSRP \$174.98

Packaged Weight: 4 lb

Packaged Dimensions: 16.5"L x 3.5"W x 12"H



Features and Benefits

- ① Durable, injection molded housing is built to last
- ② Included ground stake can be used to easily install the light in the landscape
- ③ Powerful LED with optical lens maximizes light output
- ④ Included Photocell with Digital Timer automatically controls the lights

Wiring Diagram

Wiring Diagram

- ① (3) Pre-Wired 1-Watt LED Spotlights (Included)
- ② Garden and Pond Photocell with Digital Timer (included)
- ③ Garden and Pond 6-Watt 12V Quick-Connect Transformer (included)

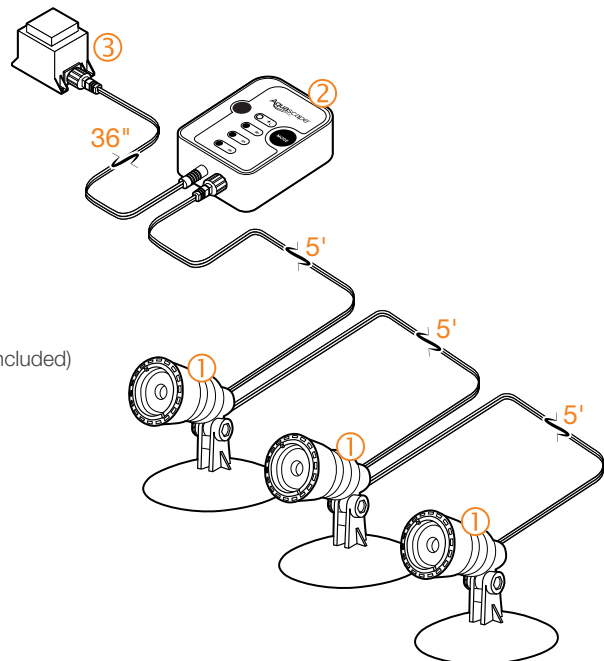

Garden and Pond LED Lights

Aquascape Garden and Pond LED Lights extend the viewing hours of your pond, waterfall, fountain, or container water garden. Excellent for both pond and landscape use, these natural, warm, white lights are easy to install and can be combined with other lights to enhance your outdoor living space.



Garden and Pond 1-Watt
LED Waterfall and Up Light

#84032 MSRP \$66.98

Garden and Pond 1-Watt
LED Spotlight

#84031 MSRP \$66.98

Garden and Pond 3-Watt
LED Spotlight

#84033 MSRP \$147.98

Garden and Pond 6-Watt
LED Spotlight

#84034 MSRP \$200.98



Features and Benefits of the LED Spotlights

- ① Durable, fully-sealed, die-cast metal housing with protective finish
- ② Optical lenses maximize light output
- ③ High-output white diodes
- ④ Removable, injection molded stand
- ⑤ Removable, injection molded landscape stake

Features and Benefits of the Waterfall and Up Light

- ① Durable, fully-sealed, die-cast metal housing with protective finish
- ② Removable, injection molded base
- ③ High-output diodes
- ④ Optical lens maximizes light output

Garden and Pond LED Lights

Wiring Diagram

Wiring Diagram

- ① Garden and Pond 6-Watt LED Spotlight (#84034)
- ② Garden and Pond 3-Watt LED Spotlight (#84033)
- ③ Garden and Pond 1-Watt LED Spotlight (#84031)
- ④ Garden and Pond 1-Watt LED Waterfall and Up (#84032)
- ⑤ Garden and Pond 3-Way Quick-Connect Splitter (#98489) (not included)
- ⑥ Garden and Pond 6-Way Quick-Connect Splitter (#84022) (not included)
- ⑦ Garden and Pond 25' Quick-Connect Lighting Extension Cable (#98998) (not included)
- ⑧ Garden and Pond Photocell with Digital Timer (#84039) (not included)
- ⑨ Transformer (not included) (required to power lights)

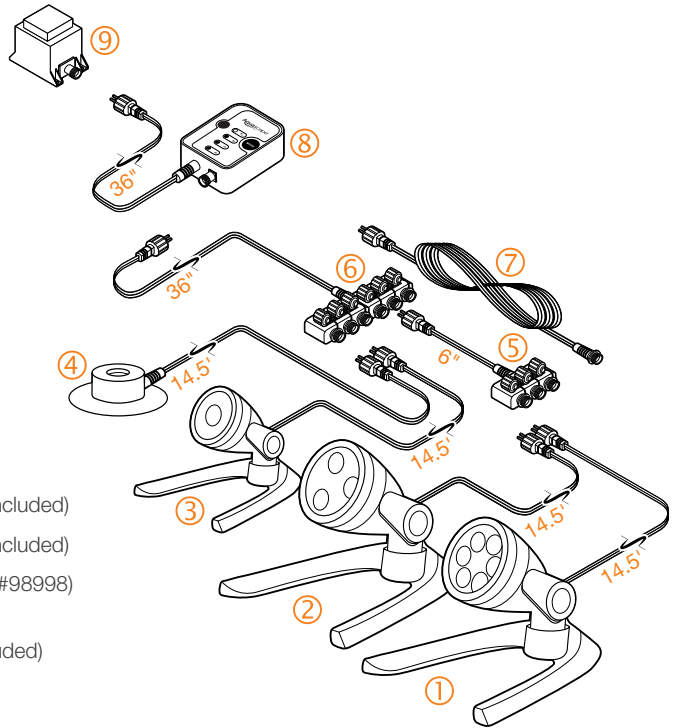

Comparison Chart

Model	1-Watt Waterfall and Up Light	1-Watt Spotlight	3-Watt Spotlight	6-Watt Spotlight
Lumens	45 lm	45 lm	150 lm	340 lm
Wattage	1.2W±10%	1.2W±10%	3W±10%	5.8W±10%
Voltage Min-Max	9V – 15V	9V – 15V	9V – 15V	9V – 15V
Temperature in Kelvin	3,000 K	3,000 K	3,000 K	3,000 K
Color Rendering Index (CRI)	75	75	75	75
Beam Angle Spread	30°	30°	30°	30°
Bulb Life	40,000 hours	40,000 hours	40,000 hours	40,000 hours
12V Quick Connect Fitting	✓	✓	✓	✓
Material	Die-Cast Metal	Die-Cast Metal	Die-Cast Metal	Die-Cast Metal
Cord Length	14.5'	14.5'	14.5'	14.5'
Light Dimensions	2" diameter x 1.5"H	1.25" diameter x 2"H	3" diameter x 3"H	3" diameter x 3"H
Packaged Weight	1 lb	1 lb	2.5 lb	2.75 lb
Packaged Dimensions	4.75"L x 4.5"W x 7.5"H	4.75"L x 3.75"W x 11"H	5"L x 5"W x 13"H	6.25"L x 6"W x 14"H

LED Fountain Lights

The Aquascape LED Fountain Lights are an excellent way to enhance your decorative fountain. The integrated fitting makes it quick and easy to install into the top of the tubing, and settles perfectly into the core of the fountain. The natural warm color gives off a warm white light, lighting up the water as it spills over the edge. The fountain lights integrate easily with other 12-volt quick-connect components.



LED Fountain Light
#84008 MSRP \$60.98

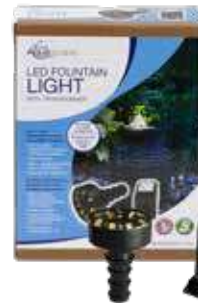

LED Fountain Light with Transformer
#84009 MSRP \$80.98



Features and Benefits

- ① Powerful LED diodes provide stunning, warm light output
- ② Durable, injection-molded housing is built to last
- ③ Integrated, removable barb fitting allows for quick and easy attachment to fountain tubing
- ④ Integrated quick-connect fitting is compatible with Aquascape quick-connect transformers, splitters, and extension cables.

Comparison Chart

Model	LED Fountain Light	LED Fountain Light with Transformer
Lumens	24 lm	24 lm
Wattage	2.5W±10%	2.5W±10%
Voltage Min-Max	10.8V – 15V	10.8V – 15V
Temperature in Kelvin	3,000 K	3,000 K
Color Rendering Index (CRI)	70	70
Beam Angle Spread	30°	30°
Bulb Life	40,000 hours	40,000 hours
12V Quick Connect Fitting	✓	✓
Material	Plastic	Plastic
Cord Length	15'	15'
Light Dimensions	1.5" diameter x 2.5"H	1.5" diameter x 2.5"H
Transformer	—	✓
Packaged Weight	1 lb	2 lb
Packaged Dimensions	2.75"L x 2.5"W x 8.25"H	5.5"L x 2.5"W x 7.25"H

Path and Area LED Landscape Lights

Aquascape Path and Area LED Landscape Lights make it easy to illuminate any landscape, including areas surrounding waterfalls, ponds, and fountains. These energy-efficient LED lights provide beauty, safety, and visibility in any residential or commercial space. The two styles available are both constructed out of durable brass and include a heavy-duty stake. These lights integrate easily with other 12-volt quick-connect components.



Path and Area 3-Watt LED Hat Top Landscape Light

#84063 MSRP \$113.98



Path and Area 3-Watt LED Dome Top Landscape Light

#84064 MSRP \$113.98



Features and Benefits

- ① Durable brass construction with antique bronze finish
- ② 3-foot lead wire with quick-connect fitting simplifies installation
- ③ Energy-efficient 3-Watt LED bulb
- ④ Acrylic lens protects LED bulb from outdoor elements
- ⑤ Highly reflective white ceramic paint for maximum light output
- ⑥ Heavy-duty stake provides simple and secure installation
- ⑦ Water-tight silicone sealed wire exit prevents moisture and insects from entering

Comparison Chart

Model	3-Watt Hat Top Landscape Light	3-Watt Dome Top Landscape Light
Lumens	270 lm	270 lm
Wattage	3W±10%	3W±10%
Voltage Min-Max	9V – 15V	9V – 15V
Temperature in Kevlin	2,700 K	2,700 K
Color Rendering Index (CRI)	80	80
Beam Angle Spread	120°	90°
Beam Spread Diameter	6.5'	6'
Bulb Life	40,000 hours	40,000 hours
12V Quick Connect Fitting	✓	✓
Material	Brass	Brass
Cord Length	3'	3'
Light Dimensions	6.5" diameter x 18.25"H	6.5" diameter x 18.25"H
Packaged Weight	1.75 lb	1.75 lb
Packaged Dimensions	5.75"L x 5.75"W x 9.25"H	5.75"L x 5.75"W x 9.25"H

Garden and Pond Photocell with Digital Timer



Garden and Pond Photocell with Digital Timer

#84039 MSRP \$37.98

Packaged Weight: 0.75 lb

Dimensions: 2"L x 1.25"W x 3.25"H with a 36" cord

- Can be used to control AquaScaper white and color-changing lights
- Auto on at dusk/off at dawn or 4, 6, 8 hour timer option
- Built-in memory setting in case of power loss
- Integrates easily with other 12-volt quick-connect components
- Up to 60-Watt capacity

Garden and Pond Extension Cables

The AquaScaper lighting extension cables allow for simple extension of AquaScaper white LED lighting. They are ideal for use with our 12-volt quick-connect transformers and 3-way and 6-way splitters. The 12V quick-connect components eliminate the need to cut wires and provide a weatherproof seal. **Not compatible with AquaScaper color-changing lights.**



Garden and Pond 25' Quick-Connect Lighting Extension Cable

#98998 MSRP \$22.98

Packaged Weight: 1 lb
25' cord length



Garden and Pond 25' 5-Outlet Quick-Connect Lighting Extension Cable

#84023 MSRP \$33.98

Packaged Weight: 1 lb
25' cord length

Garden and Pond Splitters

AquaScaper splitters provide a simple connection of 3 or 6 light fixtures to a single transformer. Multiple 3-way and 6-way splitters can be chained together to attach additional fixtures. **Not compatible with AquaScaper color-changing lights.**



Garden and Pond 3-Way Quick-Connect Splitter

#98489 MSRP \$16.98

Packaged Weight: 0.5 lb
6" cord length



Garden and Pond 6-Way Quick-Connect Splitter

#84022 MSRP \$26.98

Packaged Weight: 0.75 lb
36" cord length

LED Lighting 6-Packs

Designed for quick and easy installation of Aquascape lighting components, Aquascape 6-Packs save you money, take up less space, reduce the amount of packaging, and are ideal for installations requiring multiple lights.



Garden and Pond 1-Watt LED Waterfall and Up Light 6-Pack

#84046 MSRP \$375.98

Packaged Weight: 5.75 lb
Packaged Dimensions: 14"L x 12"W x 7"H



Garden and Pond 1-Watt LED Spotlight 6-Pack

#84045 MSRP \$375.98

Packaged Weight: 5.75 lb
Packaged Dimensions: 13.5"L x 9.75"W x 6"H



Garden and Pond 3-Watt LED Spotlight 6-Pack

#84047 MSRP \$844.98

Packaged Weight: 13.5 lb
Packaged Dimensions: 17.5"L x 15.5"W x 7"H



Garden and Pond 6-Watt LED Spotlight 6-Pack

#84048 MSRP \$1,119.98

Packaged Weight: 13.75 lb
Packaged Dimensions: 17.5"L x 15.25"W x 7.25"H



Path and Area 3-Watt LED Hat Top Landscape Light 6-Pack

#84065 MSRP \$643.98

Packaged Weight: 8.75 lb
Packaged Dimensions: 14"L x 8"W x 10"H



Path and Area 3-Watt LED Dome Top Landscape Light 6-Pack

#84066 MSRP \$643.98

Packaged Weight: 9.25 lb
Packaged Dimensions: 14"L x 8"W x 10"H

Smart Control Hub for color-changing lights

The Aquascape Smart Control Hub for color-changing lights is required to run Aquascape Color-Changing Lights, allowing you to connect to the Smart Control App on your smartphone or tablet and control your lights at anytime from anywhere. The hub is capable of a variety of lighting functions, including color selection, cycle, dimming, color themes, and more.

- Connecting your device is quick and easy, simply plug in your lights, download the Smart Control App, pair the hub to your device, and enjoy!
- Use the astronomical timer to automatically turn lights on and off based on your location.
- Create lighting zones or control separate sets of lights simultaneously by using multiple hubs, further expanding the variety of lighting options.
- Each hub can control up to 150-Watts of Aquascape Color-Changing Lights.
- 12-Volt transformer (not included) is required to power the control hub and lights. Wirelessly control a wide array of color options and settings right from your Android or iPhone.
- Adequate wireless coverage required (2.4HZ supported).



Features and Benefits

- ① WiFi Pairing Button/Indicator allows for quick and easy connection to your phone or tablet
- ② Durable, weather-resistant, injection-molded housing is built to last
- ③ Integrated hang tag provides secure mounting option
- ④ 5-pin, weather-proof, quick-connect fitting connects to Aquascape Color-Changing Lights
- ⑤ 2-pin, weather-proof, quick-connect fitting connects to power source (not included)
- ⑥ Aquascape Smart Control App allows for a variety of wireless control functions, including color selection, cycle, dimming, color themes, and more



⑥



Smart Control Hub for color-changing lights

- Turn lights on and off or select between lighting color design options
- 150-Watt lighting capacity
- Requires standard 12-volt transformer (**see page 74**)



Smart Control Hub for color-changing lights

#84074 MSRP \$133.98

Packaged Weight: .75 lb

Dimensions: 3.75"L x 2"W x .75"H

Packaged Dimensions: 4.75"L x 2"W x 4.75"H



Color-Changing Lighting Remote

#84073 MSRP \$37.98

Packaged Weight: .75 lb

Dimensions: 4.25"L x 2"W x 3/4"H

Packaged Dimensions: 4.5"L x 2.25"W x 1"H

The optional remote allows wireless control without the use of a smartphone or tablet.

LED Color-Changing Lights

Aquascape LED color-changing lights provide an impressive range of color options including a white diode that provide a true white when desired. Color-changing lights integrate easily with Aquascape color-changing lighting accessories.

Color-changing lights requires the Smart Control Hub for color-changing lights and standard 12-volt transformer.



2-Watt LED Color-Changing Waterfall and Up Light

#84057 MSRP \$133.98

4.5-Watt LED Color-Changing Spotlight

#84059 MSRP \$241.98

8-Watt LED Color-Changing Spotlight

#84060 MSRP \$309.98



Features and Benefits

- ① Durable, fully-sealed, die-cast metal housing with protective finish
- ② Optical lenses maximize light output
- ③ High-output color-changing and white diodes
- ④ Removable, injection molded stand
- ⑤ Removable, injection molded landscape stake

Comparison Chart

Model	2-Watt Waterfall and Up Light	4.5-Watt Spotlight	8-Watt Spotlight
Lumens	52 lm / White	128 lm / White	223 lm / White
Wattage	2W±10%	4.5W±10%	8W±10%
Voltage Min-Max	10.8V – 15V	10.8V – 15V	10.8V – 15V
Temperature in Kelvin	3,000 K	3,000 K	3,000 K
Color Rendering Index (CRI)	70 / White	70 / White	70 / White
Beam Angle Spread	30°	30°	30°
Bulb Life	40,000 hours	40,000 hours	40,000 hours
12V Quick Connect Fitting	✓	✓	✓
Material	Die-Cast Metal	Die-Cast Metal	Die-Cast Metal
Cord Length	15'	15'	15'
Light Dimensions	2" diameter x 1.5"H	3" diameter x 3"H	3" diameter x 3"H
Packaged Weight	1.25 lb	1.25 lb	2.75 lb
Packaged Dimensions	4.75"L x 4.5"W x 7.5"H	5.25"L x 5.25"W x 13.25"H	6.25"L x 6.25"W x 16.25"H

LED Color-Changing Fountain Lights

The Aquascape LED Color-Changing Fountain Lights provide both color-changing and white diodes for an impressive range of color options. They integrate easily with Aquascape color-changing lighting accessories and the removable fitting makes for quick and easy installation into the top of decorative fountains.



LED Color-Changing Fountain Light

#84072 MSRP \$80.98

Requires Smart Control Hub for color-changing lights and standard 12-volt transformer.



LED Color-Changing Fountain Light Kit

#84055 MSRP \$133.98

Pre-wired kit includes light, remote control and transformer. Ideal for fountain applications only requiring one light.



Features and Benefits

- ① Powerful LED diodes provide stunning light output
- ② Durable, injection-molded housing is built to last
- ③ Integrated, removable barb fitting allows for quick and easy attachment to fountain tubing
- ④ Integrated quick-connect fitting is compatible with Aquascape color-changing lighting accessories.

Comparison Chart

Model	LED Color-Changing Fountain Light	LED Color-Changing Fountain Light Kit
Lumens	20 lm / White	20 lm / White
Wattage	2W±10%	4.5W±10%
Voltage Min-Max	10.8V – 15V	10.8V – 15V
Temperature in Kelvin	3,000 K	3,000 K
Color Rendering Index (CRI)	70 / White	70 / White
Beam Angle Spread	30°	30°
Bulb Life	40,000 hours	40,000 hours
12V Quick Connect Fitting	✓	✓
Material	Plastic	Plastic
Cord Length	15'	15'
Includes Required Transformer	—	✓
Includes Required Color-Changing Hub and Remote	—	✓
Light Dimensions	1.5" diameter x 2.5"H	1.5" diameter x 2.5"H
Packaged Weight	.5 lb	2.25 lb
Packaged Dimensions	3.75"L x 1.75"W x 8.25"H	5.5"L x 2.75"W x 7.75"H

Color-Changing Lighting Extension Cables

The Aquascape color-changing lighting extension cables allow for simple extension of Aquascape color-changing lighting. They are ideal for use with our 12-volt quick-connect transformers and 3-way and 6-way splitters. The 12-volt quick-connect components eliminate the need to cut wires and provide a weatherproof seal. **Not compatible with Aquascape LED white lights.**



25' Color-Changing Lighting Extension Cable

#84069 MSRP \$46.98



25' 5-Outlet Color-Changing Lighting Extension Cable

#84070 MSRP \$66.98

Color-Changing Lighting Splitters

Aquascape color-changing splitters provide a simple connection of 3 or 6 color-changing fixtures to a single power source. Multiple 3-way and 6-way splitters can be chained together to attach additional fixtures. **Not compatible with Aquascape LED white lights.**



3-Way Color-Changing Splitter

#84062 MSRP \$40.98



6-Way Color-Changing Splitter

#84068 MSRP \$80.98

Comparison Chart

Model	25' Color-Changing Extension Cable	25' 5-Outlet Color-Changing Extension Cable	3-Way Color-Changing Splitter	6-Way Color-Changing Splitter
Quick-Connect Connections	1	5	3	6
Type of Quick-Connect	5-Prong	5-Prong	5-Prong	5-Prong
Cord Length	25'	25'	6"	36"
Packaged Weight	1.25 lb	1.5 lb	0.25 lb	.75 lb
Packaged Dimensions	7.25"L x 1.75"W x 5.75"H	7"L x 2.5"W x 6.25"H	4"L x 1.5"W x 3"H	7.25"L x 1.75"W x 2"H



POWER

Aquascape low-voltage products like LED lighting and the Pond Powerhead require 12-volt transformers.

Aquascape offers a variety of power accessories including an array of low-voltage transformers and a Smart Control Plug designed to control your Aquascape products with the Smart Control App on your smartphone or tablet.

Transformers

Aquascape transformers provide an economical solution for operating low-voltage products such as lighting or Pond Powerheads. A variety of power options are available and each transformer includes quick-connect connections for quick and easy installation.



Garden and Pond
6-Watt 12V Quick-Connect
Transformer
#98375 MSRP \$33.98

Garden and Pond
20-Watt 12V Quick-Connect
Transformer
#98485 MSRP \$66.98

Garden and Pond
60-Watt 12V Quick-Connect
Transformer
#98486 MSRP \$87.98

Garden and Pond
150-Watt Transformer with Photocell
#01002 MSRP \$199.98

Garden and Pond
60-Watt Transformer with Photocell
#99070 MSRP \$120.98

Comparison Chart

Model	6-Watt Transformer	20-Watt Transformer	60-Watt Transformer	60-Watt Transformer with Photocell	150-Watt Transformer with Photocell
Quick-Connect Connections	1	1	1	1	3
Type of Quick-Connect	2-Prong	2-Prong	2-Prong	2-Prong	2-Prong
Photocell included	—	—	—	✓	✓
Transformer Dimensions	3"L x 1.5"W x 2.25"H	4"L x 1.75"W x 2.5"H	3"L x 6"W x 3"H	3.5"L x 7"W x 2.5"H	4"L x 7"W x 3.5"H
Packaged Weight	1 lb	1.75 lb	3.5 lb	4 lb	8 lb
Packaged Dimensions	6.5"L x 3"W x 4.5"H	6.25"L x 2"W x 4"H	6"L x 2"W x 4"H	8.75"L x 7.5"W x 4.25"H	7.75"L x 4"W x 4"H

Smart Control Plug

The Aquascape Smart Plug is the easiest way to add smart controls to your existing Aquascape water features, allowing you to control your lights, pumps, or any other outdoor appliance from anywhere using your smartphone or tablet.

- Numbered outlets allow simple, clear set-up
- Power monitoring shows energy consumption of connected devices
- Adequate wireless coverage required (2.4HZ supported)



Smart Control Plug
#82001 MSRP \$69.98

Packaged Weight: .5 lb

Dimensions: 6"L x 1.5"W x 5.5"H with a 6" cord

Packaged Dimensions: 7"L x 2"W x 6"H





WATER TREATMENTS

Aquascape Water Treatments

Combining science with simplicity, Aquascape makes it easy to maintain a healthy, well-balanced water feature.

Aquascape Water Treatments make dosing simple and affordable. Put away your calculator and enjoy a clean, clear, and healthy ecosystem pond, Pondless® Waterfall, or decorative fountain with the complete line of Aquascape water treatment products

Water Treatment Options

Aquascape has a variety of options to naturally and efficiently balance your pond or waterfall. Select from Simple Solutions, Beneficial Bacteria, Problem Solving, Water Conditioners, Sludge Fighting, Fountain Treatments, and Lake and Large Pond Treatments.

Water Treatments

Simple Solutions

Maintain your water feature easily by tackling water quality and clarity issues with this line of easy-to-use water treatments and products. Choose between the Automatic Dosing System or manual pump-top bottles to dispense our specially-formulated water treatments.

Beneficial Bacteria

Aquascape beneficial bacteria water treatments are perfect for weekly application to maintain and establish balanced ecosystems. These treatments keep water clean, clear, and healthy.

Sludge Fighting

Aquascape sludge fighting water treatments eliminate and prevent pond sludge caused by fish waste, plant matter, and other decaying materials. These treatments keep rocks, gravel, and filters clean and provide clean, clear, and healthy water conditions.

Water Conditioners

Aquascape water conditioners help achieve ideal water conditions in ponds and other water features, making water safe for fish and caring for ponds simple and easy.

Problem Solving

Aquascape Problem Solving water treatments quickly resolve a variety of problems, from clearing cloudy water to removing debris from rocks and gravel.

Fountain Treatments

Aquascape Fountain Treatments clean fountain surfaces and eliminate unsightly conditions including scale build-up, debris, and foam.

Lake and Large Pond Treatments

Aquascape Lake and Large Pond Treatments are intended for lake and large pond use only. These formulations are optimized specifically for larger bodies of water.

Simple Solutions

The Automatic Dosing System (ADS) is an electronically-operated dispenser that accurately and consistently applies your choice of specially-formulated water treatments to your water feature. The automatic dosing process eliminates the guesswork and routine associated with adding water treatments manually.

Aquascape offers an Automatic Dosing System for Ponds with four available water treatment options, and an Automatic Dosing System for Fountains with two available water treatment options.



Automatic Dosing System for Ponds
#96030 MSRP \$174.98
 Packaged Weight: 6 lb
 Packaged Dimensions: 9"L x 8.25"W x 14.5"H

- Free water treatment included (Maintain for Ponds)
- Ideal for use with ponds and water gardens



Automatic Dosing System for Fountains
#96031 MSRP \$174.98
 Packaged Weight: 6 lb
 Packaged Dimensions: 9"L x 8.25"W x 14.5"H

- Free water treatment
- Ideal for use with fountains and Pondless® Waterfalls



Features and Benefits

- ① Water feature size indication** – The control panel shows the selected size of your water feature by displaying a blue light next to the number of gallons of water. The dosing system dispenses treatment into your water feature based on this number.
- ② Increase/decrease pond size** – Use the plus (+) and minus (-) buttons to select the approximate number of gallons in your water feature.
- ③ X2 button** – When pressed once, the 2 button will double the dosage for new ponds, problem ponds, or after a cleaning. When held, the system will enter a priming mode, automatically priming the system for newly installed water treatment pouches.



Replacement Frequency

Water Feature Size	Approximate Days of Treatment
Up to 500 gal / 1 893 L	166
1,000 gal / 3 785 L	83
1,500 gal / 5 678 L	55
2,000 gal / 7 571 L	42
2,500 gal / 9 464 L	33
3,000 gal / 11 356 L	28
3,500 gal / 13 249 L	24
4,000 gal / 15 142 L	21
4,500 gal / 17 034 L	18
5,000 gal / 18 927 L	16

Simple Solutions Water Treatments for Ponds

Maintain for Ponds

Use on a daily basis to keep ponds clean, clear, and healthy

Maintain for Ponds reduces maintenance and promotes optimum water quality by combining our most effective water treatments into one powerful application. The formulation includes a beneficial bacteria blend, phosphate binder, flocculant, and dextoxifier, resulting in a healthy, crystal-clear, maintenance-free pond.



Maintain for Ponds
for use with the Automatic Dosing System

#96032 MSRP \$40.98

Packaged Weight: 2.25 lb

Clear for Ponds

Use to clear unsightly water conditions, including cloudy and discolored water

Clear for Ponds uses a concentrated formulation of clarifiers to effectively resolve existing water quality problems, including cloudy or discolored water, and issues with debris attached to rocks and gravel. The formulation also contains a phosphate binder which works to prevent issues with water clarity and debris buildup.



Clear for Ponds
for use with the Automatic Dosing System

#96033 MSRP \$40.98

Packaged Weight: 2.25 lb



Maintain for Ponds
for manual pump top dosing

8 oz / 236 ml – #96057 MSRP \$20.98

Packaged Weight: .75 lb

1 pump treats 100 gal / 378 L
1 bottle treats 5,000 gal / 18,900 L

16 oz / 473 ml – #96058 MSRP \$26.98

Packaged Weight: 1.25 lb

1 pump treats 100 gal / 378 L
1 bottle treats 10,000 gal / 37,800 L

32 oz / 946 ml – #96059 MSRP \$44.98

Packaged Weight: 2.5 lb

1 pump treats 100 gal / 378 L
1 bottle treats 20,000 gal / 75,600 L

1 gal / 3.78 L – #96060 MSRP \$107.98

Packaged Weight: 8 lb

1 pump treats 600 gal / 2,268 L
1 bottle treats 80,000 gal / 302,400 L



Clear for Ponds
for manual pump top dosing

8 oz / 236 ml – #96065 MSRP \$20.98

Packaged Weight: .75 lb

1 pump treats 100 gal / 378 L
1 bottle treats 5,000 gal / 18,900 L

16 oz / 473 ml – #96066 MSRP \$26.98

Packaged Weight: 1.25 lb

1 pump treats 100 gal / 378 L
1 bottle treats 10,000 gal / 37,800 L

32 oz / 946 ml – #96067 MSRP \$44.98

Packaged Weight: 2.5 lb

1 pump treats 100 gal / 378 L
1 bottle treats 20,000 gal / 75,600 L

1 gal / 3.78 L – #96068 MSRP \$107.98

Packaged Weight: 8 lb

1 pump treats 600 gal / 2,268 L
1 bottle treats 80,000 gal / 302,400 L

Simple Solutions Water Treatments for Ponds

Clean for Ponds

Use to naturally reduce organic sludge and debris

Clean for Ponds uses a powerful blend of heterotrophic bacteria to digest organic waste or sludge caused by uneaten fish food, fish waste, and leaves or debris, naturally cleaning the rocks and gravel. Reducing organic waste keeps ponds and pond filters clean while optimizing water clarity and quality.



Clean for Ponds

for use with the Automatic Dosing System

#96034 MSRP \$40.98

Packaged Weight: 2.25 lb

Protect for Ponds

Use to reduce fish stress, prevent parasites and infections, and accelerate healing

Protect for Ponds uses an all-natural formulation of tea tree oil and other plant-based biopolymers to effectively protect pond fish, reduce fish stress, prevent parasites and infections, and accelerate healing of superficial wounds, scrapes, and breeding abrasions. Protect is great for use after handling fish or performing cleanouts and water changes.



Protect for Ponds

for use with the Automatic Dosing System

#96035 MSRP \$40.98

Packaged Weight: 2.25 lb



Clean for Ponds

for manual pump top dosing

8 oz / 236 ml – #96061 MSRP \$20.98

Packaged Weight: .75 lb

1 pump treats 100 gal / 378 L

1 bottle treats 5,000 gal / 18,900 L

16 oz / 473 ml – #96062 MSRP \$26.98

Packaged Weight: 1.25 lb

1 pump treats 100 gal / 378 L

1 bottle treats 10,000 gal / 37,800 L

32 oz / 946 ml – #96063 MSRP \$44.98

Packaged Weight: 2.5 lb

1 pump treats 100 gal / 378 L

1 bottle treats 20,000 gal / 75,600 L

1 gal / 3.78 L – #96064 MSRP \$107.98

Packaged Weight: 8 lb

1 pump treats 600 gal / 2,268 L

1 bottle treats 80,000 gal / 302,400 L



Protect for Ponds

for manual pump top dosing

8 oz / 236 ml – #96069 MSRP \$20.98

Packaged Weight: .75 lb

1 pump treats 100 gal / 378 L

1 bottle treats 5,000 gal / 18,900 L

16 oz / 473 ml – #96070 MSRP \$26.98

Packaged Weight: 1.25 lb

1 pump treats 100 gal / 378 L

1 bottle treats 10,000 gal / 37,800 L

32 oz / 946 ml – #96071 MSRP \$44.98

Packaged Weight: 2.5 lb

1 pump treats 100 gal / 378 L

1 bottle treats 20,000 gal / 75,600 L

1 gal / 3.78 L – #96072 MSRP \$107.98

Packaged Weight: 8 lb

1 pump treats 600 gal / 2,268 L

1 bottle treats 80,000 gal / 302,400 L

Simple Solutions Water Treatments for Fountains

Prevent for Fountains

Use on a daily basis to keep waterfalls and fountains clean and clear

Prevent for Fountains keeps waterfalls and fountains clean and clear, controlling white-scale buildup, foam, stains, and unsightly water conditions without damaging surfaces. The formulation contains a special blend of clarifiers, designed to prevent debris buildup. **Prevent for Fountains is not intended for use in water features containing fish or plants.**



Prevent for Fountains
for use with the Automatic Dosing System

#96042 MSRP \$40.98

Packaged Weight: 2.25 lb

Clean for Fountains

Use to clear unsightly suspended debris

Clean for Fountains effectively cleans and clarifies waterfalls and fountains with pooling water, plants, or fish, significantly reducing maintenance and improving water quality. The formulation contains a flocculant and powerful phosphate binder to help clear and prevent unsightly suspended debris. **Clean for Fountains is safe for use with fish and plants.**



Clean for Fountains
for use with the Automatic Dosing System

#96037 MSRP \$40.98

Packaged Weight: 2.25 lb



Prevent for Fountains
for manual pump top dosing

8 oz / 236 ml – #96073 MSRP \$20.98

Packaged Weight: .75 lb

1 pump treats 100 gal / 378 L

1 bottle treats 5,000 gal / 18,900 L

16 oz / 473 ml – #96074 MSRP \$26.98

Packaged Weight: 1.25 lb

1 pump treats 100 gal / 378 L

1 bottle treats 10,000 gal / 37,800 L

32 oz / 946 ml – #96075 MSRP \$44.98

Packaged Weight: 2.5 lb

1 pump treats 100 gal / 378 L

1 bottle treats 20,000 gal / 75,600 L

1 gal / 3.78 L – #96076 MSRP \$107.98

Packaged Weight: 8 lb

1 pump treats 600 gal / 2,268 L

1 bottle treats 80,000 gal / 302,400 L



Clean for Fountains
for manual pump top dosing

8 oz / 236 ml – #96077 MSRP \$20.98

Packaged Weight: .75 lb

1 pump treats 100 gal / 378 L

1 bottle treats 5,000 gal / 18,900 L

16 oz / 473 ml – #96078 MSRP \$26.98

Packaged Weight: 1.25 lb

1 pump treats 100 gal / 378 L

1 bottle treats 10,000 gal / 37,800 L

32 oz / 946 ml – #96079 MSRP \$44.98

Packaged Weight: 2.5 lb

1 pump treats 100 gal / 378 L

1 bottle treats 20,000 gal / 75,600 L

1 gal / 3.78 L – #96080 MSRP \$107.98

Packaged Weight: 8 lb

1 pump treats 600 gal / 2,268 L

1 bottle treats 80,000 gal / 302,400 L

Beneficial Bacteria



Beneficial Bacteria

- Contains 8 strains of bacteria including photosynthetic
- Contains marigold and vitamin B)

8 oz / 236 ml

#98886 MSRP \$18.98

Packaged Weight: .75 lb

1 pump treats 100 gal / 378 L

1 bottle treats 5,000 gal / 18,900 L

16 oz / 473 ml

#98887 MSRP \$26.98

Packaged Weight: 1.25 lb

1 pump treats 100 gal / 378 L

1 bottle treats 10,000 gal / 37,800 L

32 oz / 946 ml

#98888 MSRP \$46.98

Packaged Weight: 2.5 lb

1 pump treats 100 gal / 378 L

1 bottle treats 20,000 gal / 75,600 L

Refill Pouch 32 oz / 946 ml

#40002 MSRP \$26.98

Packaged Weight: 2.25 lb

1oz treats 600 gal / 2,268 L

1 bottle treats 20,000 gal / 75,600 L

1 gal / 3.78 L

#98885 MSRP \$107.98

Packaged Weight: 8 lb

1 pump treats 600 gal / 2,268 L

1 bottle treats 80,000 gal / 302,400 L



Beneficial Bacteria Concentrate

- Contains 8 strains of bacteria including photosynthetic
- Contains marigold and vitamin B
- Ideal for larger ponds

4.4 oz / 125 g

#98925 MSRP \$17.98

Packaged Weight: 0.25 lb

1 scoop treats 1,300 gal / 4,914 L

1 container treats 26,000 gal / 98,280 L

8.8 oz / 250 g

#98948 MSRP \$26.98

Packaged Weight: .75 lb

1 scoop treats 1,300 gal / 4,914 L

1 container treats 52,000 gal / 196,560 L

1.1 lb / 500 g

#98949 MSRP \$46.98

Packaged Weight: 1.25 lb

1 scoop treats 1,300 gal / 4,914 L

1 container treats 104,000 gal / 393,120 L

7 lb / 3.2 kg

#98950 MSRP \$201.98

Packaged Weight: 7.5 lb

1 scoop treats 1,300 gal / 4,914 L

1 container treats 665,600 gal / 2,515,968 L



Cold Water Beneficial Bacteria

- Reduces ammonia, nitrite, and organic debris
- Ideal for use in water colder than 50°F (5°C)

8 oz / 236 ml

#98892 MSRP \$20.98

Packaged Weight: .75 lb

1 pump treats 100 gal / 378 L

1 bottle treats 5,000 gal / 18,900 L

16 oz / 473 ml

#98893 MSRP \$33.98

Packaged Weight: 1.25 lb

1 pump treats 100 gal / 378 L

1 bottle treats 10,000 gal / 37,800 L

32 oz / 946 ml

#98894 MSRP \$53.98

Packaged Weight: 2.5 lb

1 pump treats 100 gal / 378 L

1 bottle treats 20,000 gal / 75,600 L

1 gal / 3.78 L

#96021 MSRP \$134.98

Packaged Weight: 8 lb

1 pump treats 600 gal / 2,268 L

1 bottle treats 80,000 gal / 302,400 L

Beneficial Bacteria (Continued)



Pond Starter Bacteria

- Quickly establishes biological ecosystem
- Great for spring start-ups and new ponds
- Safe for fish, plants, and animals

8 oz / 236 ml

#96013 MSRP \$21.98

Packaged Weight: 0.6 lb

1 pump treats 100 gal / 378 L
1 bottle treats 5,000 gal / 18,900 L

16 oz / 473 ml

#96014 MSRP \$33.98

Packaged Weight: 1.25 lb

1 pump treats 100 gal / 378 L
1 bottle treats 10,000 gal / 37,800 L

32 oz / 946 ml

#96015 MSRP \$53.98

Packaged Weight: 2.5 lb

1 pump treats 100 gal / 378 L
1 bottle treats 20,000 gal / 75,600 L

1 gal / 3.78 L

#96008 MSRP \$120.98

Packaged Weight: 8 lb

1 pump treats 600 gal / 2,268 L
1 bottle treats 80,000 gal / 302,400 L



Bacteria Bubble Tabs

- Keeps pond water clean and clear
- Maintains a balanced ecosystem
- Reduces pond maintenance

36 Tabs

#98951 MSRP \$20.98

Packaged Weight: 0.25 lb

1 tablet treats 100 gal / 378 L
1 container treats 3,600 gal / 13,608 L

72 Tabs

#98930 MSRP \$33.98

Packaged Weight: .75 lb

1 tablet treats 100 gal / 378 L
1 container treats 7,200 gal / 27,216 L

Sludge Fighting



Pond Sludge Remover Packs

- Eliminates and prevents pond sludge
- Water soluble packs make it easy to spot-treat and treat hard to reach areas
- Keeps rocks, gravel, and filters clean

18 Packs

#96081 MSRP \$26.98

Packaged Weight: .5 lb

1 pack treats 1,000 gal / 3,780 L

1 container treats 18,000 gal / 68,040 L

36 Packs

#96084 MSRP \$44.98

Packaged Weight: 1 lb

1 pack treats 1,000 gal / 3,780 L

1 container treats 32,000 gal / 120,960 L

72 Packs

#96082 MSRP \$80.98

Packaged Weight: 2.5 lb

1 pack treats 1,000 gal / 3,780 L

1 container treats 72,000 gal / 272,550 L



Sludge & Filter Cleaner

- Biological pond and filter cleaner
- Contains 5 strains of heterotrophic bacteria
- Contains marigold and humic acid
- Safe for fish, plants, and animals

8 oz / 236 ml

#98889 MSRP \$18.98

Packaged Weight: .75 lb

1 pump treats 100 gal / 378 L

1 bottle treats 5,000 gal / 18,900 L

16 oz / 473 ml

#98890 MSRP \$26.98

Packaged Weight: 1.25 lb

1 pump treats 100 gal / 378 L

1 bottle treats 10,000 gal / 37,800 L

32 oz / 946 ml

#98891 MSRP \$46.98

Packaged Weight: 2.5 lb

1 pump treats 100 gal / 378 L

1 bottle treats 20,000 gal / 75,600 L

1 gal / 3.78 L

#98883 MSRP \$120.98

Packaged Weight: 8 lb

1 pump treats 600 gal / 2,268 L

1 bottle treats 80,000 gal / 302,400 L



Sludge Cleaner Bubble Tabs

- Pond bottom and filter cleaner
- Bubble Tabs help disperse sludge-eating bacteria quickly
- Safe for fish, plants, or animals

36 Tabs

#98901 MSRP \$21.98

Packaged Weight: 0.25 lb

1 tablet treats 100 gal / 378 L

1 container treats 3,600 gal / 13,608 L

72 Tabs

#98902 MSRP \$33.98

Packaged Weight: .75 lb

1 tablet treats 100 gal / 378 L

1 container treats 7,200 gal / 27,216 L

Water Conditioners



Pond Detoxifier

- Makes tap water safe for fish and plants
- Removes and detoxifies chlorine
- Neutralizes ammonia
- Detoxifies and chelates copper and heavy metal

8 oz / 236 ml - **#98876** MSRP **\$14.98**

Packaged Weight: .75 lb
1 pump treats 100 gal / 378 L
1 bottle treats 5,000 gal / 18,900 L

16 oz / 473 ml - **#98877** MSRP **\$21.98**

Packaged Weight: 1.25 lb
1 pump treats 100 gal / 378 L
1 bottle treats 10,000 gal / 37,800 L

Refill Pouch 32 oz / 946 ml
#40005 MSRP **\$33.98**

Packaged Weight: 2.25 lb
1 oz treats 600 gal / 2,268 L
1 bottle treats 20,000 gal / 75,600 L

1 gal / 3.78 L - **#96010** MSRP **\$120.98**

Packaged Weight: 8 lb
1 pump treats 600 gal / 2,268 L
1 bottle treats 80,000 gal / 302,400 L



Ammonia Neutralizer

- Neutralizes large concentrations of toxic ammonia
- Makes pond water safe for fish and plants
- Detoxifies chloramine in tap water

16 oz / 473 ml - **#96050** MSRP **\$26.98**

Packaged Weight: 1.25 lb
1 pump treats 100 gal / 378 L
1 bottle treats 10,000 gal / 37,800 L

32 oz / 946 ml - **#96051** MSRP **\$46.98**

Packaged Weight: 2.5 lb
1 pump treats 100 gal / 378 L
1 bottle treats 20,000 gal / 75,600 L

1 gal / 3.78 L - **#96052** MSRP **\$107.98**

Packaged Weight: 8 lb
1 pump treats 600 gal / 2,268 L
1 bottle treats 80,000 gal / 302,400 L



Alkalinity Booster

- Increases overall KH/pH and alkalinity
- Lab tested and pharmaceutical grade
- Dissolves completely and easily in pond water
- Phosphate and ammonia free

1.1 lb / 500 g - **#96027** MSRP **\$26.98**

Packaged Weight: 3 lb
1 scoop treats 125 gal / 472 L
1 container treats 5,000 gal / 18,900 L

9 lb / 4.08 kg - **#96028** MSRP **\$46.98**

Packaged Weight: 9.75 lb
1 scoop treats 125 gal / 472 L
1 container treats 40,750 gal / 154,035 L



Pond Foam Free

- Safely eliminates foam near waterfalls
- Helps maintain the beauty of your pond
- Helps keep water clean and clear of foam
- Safe for fish, animals, and plants

8 oz / 236 ml - **#98909** MSRP **\$21.98**

Packaged Weight: .75 lb
1 pump treats 100 gal / 378 L
1 bottle treats 5,000 gal / 18,900 L



Activated Pond Carbon

- Removes discoloration and odors
- Made with bamboo carbon
- Clarifies pond water
- Quickly reduces pond odor

2.25 lb / 1 kg - **#80000** MSRP **\$33.98**

Packaged Weight: 2.25 lb
1 scoop treats 25 gal / 95 L
1 container treats up to 800 gal / 3,024 L

Problem Solving



SAB Stream & Pond Cleaner

- Breaks down debris
- Maintains a balanced ecosystem
- Reduces pond maintenance
- Phosphate binder

4.4 oz / 125 g

#98898 MSRP \$17.98

Packaged Weight: 0.25 lb

1 scoop treats 120 gal / 454 L

1 container treats 1,200 gal / 4,536 L

8.8 oz / 250 g

#98899 MSRP \$26.98

Packaged Weight: .75 lb

1 scoop treats 120 gal / 454 L

1 container treats 2,400 gal / 9,072 L

1.1 lb / 500 g

#98900 MSRP \$46.98

Packaged Weight: 1.25 lb

1 scoop treats 120 gal / 454 L

1 container treats 4,920 gal / 18,597 L

7 lb / 3.2 kg

#98896 MSRP \$200.98

Packaged Weight: 7.5 lb

1 scoop treats 1,420 gal / 5,368 L

1 container treats 31,240 gal / 118,087 L



Barley Straw Extract

- Promotes clean, clear water conditions in ponds and streams
- Starts working instantly
- Concentrated formulation with added enzymes

8 oz / 236 ml

#98903 MSRP \$14.98

Packaged Weight: .75 lb

1 pump treats 100 gal / 378 L

1 bottle treats 5,000 gal / 18,900 L

16 oz / 473 ml

#98904 MSRP \$21.98

Packaged Weight: 1.25 lb

1 pump treats 100 gal / 378 L

1 bottle treats 10,000 gal / 37,800 L

32 oz / 946 ml

#98905 MSRP \$38.98

Packaged Weight: 2.5 lb

1 pump treats 100 gal / 378 L

1 bottle treats 20,000 gal / 75,600 L

1 gal / 3.78 L

#96012 MSRP \$133.98

Packaged Weight: 8 lb

1 pump treats 600 gal / 2,268 L

1 bottle treats 80,000 gal / 302,400 L



Rapid Clear Flocculant

- Quickly clears cloudy water by clumping debris
- Works within 24 hours
- For best results, use in combination with a Rapid Clear Fine Filter Pad (#80001)

8 oz / 236 ml

#98879 MSRP \$21.98

Packaged Weight: .75 lb

1 pump treats 100 gal / 378 L

1 bottle treats 5,000 gal / 18,900 L

16 oz / 473 ml

#96049 MSRP \$26.98

Packaged Weight: 1.25 lb

1 pump treats 100 gal / 378 L

1 bottle treats 10,000 gal / 37,800 L

Refill Pouch 32 oz / 946 ml

#40006 MSRP \$33.98

Packaged Weight: 2.25 lb

1oz treats 600 gal / 2,268 L

1 bottle treats 20,000 gal / 75,600 L

1 gal / 3.78 L

#96007 MSRP \$120.98

Packaged Weight: 8 lb

1 pump treats 600 gal / 2,268 L

1 bottle treats 80,000 gal / 302,400 L



Rapid Clear Fine Filter Pads

- Speeds-up filtering of flocculated particles
- For best results, use in combination with Rapid Clear Flocculant water treatments
- Enhances water quality
- Includes three pads

#80001 MSRP \$21.98

Packaged Weight: .75 lb

12"W x 24"L

Problem Solving



Pond and Debris Clarifier

- Quickly cleans unsightly debris
- Scientifically blended to quickly restore the water quality
- Reduces pond maintenance

8 oz / 236 ml

#96002 MSRP \$12.98

Packaged Weight: 0.7 lb

1 pump treats 100 gal / 378 L
1 bottle treats 5,000 gal / 18,900 L

16 oz / 473 ml

#96003 MSRP \$17.98

Packaged Weight: 1.2 lb

1 pump treats 100 gal / 378 L
1 bottle treats 10,000 gal / 37,800 L

32 oz / 946 ml

#96005 MSRP \$33.98

Packaged Weight: 2.2 lb

1 pump treats 100 gal / 378 L
1 bottle treats 20,000 gal / 75,600 L

Refill Pouch 32 oz / 946 ml

#96004 MSRP \$27.98

Packaged Weight: 9 lb

1 oz treats 600 gal / 2,268 L
1 pouch treats 20,000 gal / 75,600 L

1 gal / 3.78 L

#96006 MSRP \$89.98

Packaged Weight: 9.2 lb

1 pump treats 600 gal / 2,268 L
1 bottle treats 80,000 gal / 302,400 L



Concentrated Barley Straw Pellets

- Fast-acting, natural way to clarify pond water
- Comes in a resealable mesh bag
- Contains a blend of bacteria and enzymes

5 lb / 2.3 kg

#96029 MSRP \$33.98

Packaged Weight: 5.5 lb

1 container treats 1,000 gal / 3,780 L



Black Pond Dye

- Filters sunlight and cools water
- Contains humic acid and enzymes to help balance the pond ecosystem
- Creates a shimmering effect
- One dosage lasts up to 6 weeks

8 oz / 236 ml

#98884 MSRP \$21.98

Packaged Weight: .75 lb

1 pump treats 100 gal / 378 L
1 bottle treats 5,000 gal / 18,900 L



Blue Pond Dye

- Added enzymes help balance the pond ecosystem
- One dosage lasts up to 6 weeks

8 oz / 236 ml

#98882 MSRP \$22.98

Packaged Weight: .75 lb

1 pump treats 100 gal / 378 L
1 bottle treats 5,000 gal / 18,900 L

Problem Solving (Continued)



QuickFix Pond Gummy

- Rapidly resolves pond problems, including cloudy water
- Innovative gummy makes for quick and easy application
- Targets ammonia, nitrite, and phosphate
- Helps control organic waste and debris

#96083 MSRP \$13.98

Packaged Weight: 0.25 lb

1 package treats 3,000 gal / 11,340 L



Features and Benefits

- ① Each gummy sits in a solution containing a special blend of treatments.
 - Helps clear unsightly water conditions
 - Provides an instantaneous bio-available food source to maximize metabolic activity
- ② The gummy contains:
 - 320 billion viable bacteria cultures specifically selected for their ability to quickly resolve a variety of pond problems
 - Free enzymes which trigger digestion to help break down organics

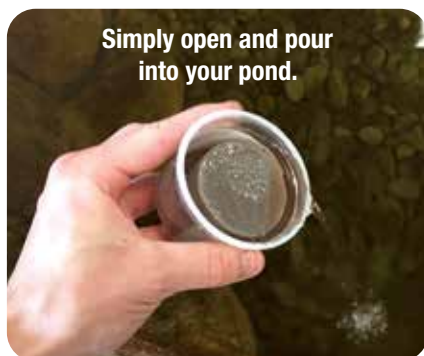

Fountain Treatments



Patio Pond Maintenance Tabs

- Targeted treatment for container water gardens
- Contains 8 pure strains of beneficial bacteria
- Helps optimize water quality
- Safe for fish, animals, and plants

36 Tabs

#40004 MSRP \$20.98

Packaged Weight: 0.25 lb

1 tablet treats 100 gal / 378 L

1 container treats 3,600 gal / 13,608 L



Fountain Foam Free

- Safely eliminates foam from water features
- Helps maintain the beauty of your water feature
- Helps keep water clean and clear of foam
- Safe for fish, animals, and plants

8 oz / 236 ml

#98908 MSRP \$21.98

Packaged Weight: .75 lb

1 pump treats 10 gal / 37.8 L

1 bottle treats 500 gal / 1,890 L



Rock & Fountain Cleaner

- Quickly eliminates debris from waterfalls, fountains, or streams
- Easy-to-use spray bottle application
- Safe for fish, animals, and plants

32 oz / 946 ml

#96055 MSRP \$30.98

Packaged Weight: 2.5 lb

1 bottle treats up to 300 sq. ft.



Fountain Maintenance

- Safely eliminates scale and debris build-up from water features
- Maintains the beauty of your water feature
- Helps maintain perfect water quality
- Prevents white scale build-up without damaging feature
- Safe for fish, animals, and plants

8 oz / 236 ml

#40007 MSRP \$26.98

Packaged Weight: .75 lb

1 pump treats 10 gal / 37.8 L

1 bottle treats 500 gal / 1,890 L

16 oz / 473 ml

#96056 MSRP \$37.98

Packaged Weight: 1.25 lb

1 pump treats 10 gal / 37.8 L

1 bottle treats 1,000 gal / 3,785 L



Fountain Scale Free

- Safely removes calcium and scale from water features
- Helps keep water clean and clear of hard water deposits, white scale, and foam
- Adds the fresh clean scent of lavender
- Safe for fish, animals, and plants

8 oz / 236 ml

#98907 MSRP \$21.98

Packaged Weight: .75 lb

1 pump treats 10 gal / 37.8 L

1 bottle treats 500 gal / 1,890 L

Professional Grade Water Treatments

Aquascape Professional Grade Water Treatments are 25% more concentrated than the consumer equivalent. The graduated measuring cup allows larger doses to be easily applied.



Beneficial Bacteria Professional Grade

- Provides clean, clear, and healthy water conditions
- Contains photosynthetic bacteria
- Contains marigold and vitamin B

1 gal / 3.78 L

#30406 MSRP \$134.99

Packaged Weight: 8.75 lb

1 scoop treats 6,000 gal / 22,680 L

1 bottle treats 96,000 gal / 362,880 L



Beneficial Bacteria Concentrate Professional Grade

- Provides clean, clear, and healthy water conditions
- Contains 8 strains of bacteria
- Contains photosynthetic bacteria

9 lb / 4.08 kg

#30407 MSRP \$267.99

Packaged Weight: 9.5 lb

1 scoop treats 48,000 gal / 181,440 L

1 container treats 672,000 gal / 2,540,160 L



Cold Water Beneficial Bacteria Professional Grade

- Provides clean, clear, and healthy water conditions
- Reduces ammonia, nitrite, and organic debris
- Ideal for use in water colder than 50°F (5°C)

1 gal / 3.78 L

#98895 MSRP \$134.99

Packaged Weight: 8.75 lb

1 scoop treats 6,000 gal / 22,680 L

1 bottle treats 96,000 gal / 362,880 L



Pond Starter Bacteria Professional Grade

- Establishes biological ecosystem
- Great for spring start-up and new ponds

1 gal / 3.78 L

#40011 MSRP \$134.99

Packaged Weight: 9 lb

1 scoop treats 6,000 gal / 22,712 L

1 container treats 96,000 gal / 363,400 L



Wetland Pond & Lake Bacteria Professional Grade

- Naturally reduces ammonia, nitrate, and excess nutrients
- Includes 8 pure strains of beneficial bacteria, including photosynthetic bacteria
- Maintains a balanced ecosystem

1 gal / 3.78 L

#98897 MSRP \$160.99

Packaged Weight: 9 lb

1 scoop treats 48,000 gal / 181,440 L

1 container treats 768,000 gal / 2,903,040 L



Rapid Clear Flocculant Professional Grade

- Clears discolored or cloudy water
- Clumps suspended debris (flocculation)
- Clears most ponds in 24 hours

1 gal / 3.78 L

#30412 MSRP \$134.99

Packaged Weight: 9 lb

1 scoop treats 6,000 gal / 22,712 L

1 container treats 96,000 gal / 363,400 L



Pond & Debris Clarifier Professional Grade

- Quickly cleans unsightly debris
- Restores water quality
- Reduces pond maintenance

1 gal / 3.78 L

#40010 MSRP \$107.99

Packaged Weight: 9 lb

1 scoop treats 6,000 gal / 22,712 L

1 container treats 96,000 gal / 363,400 L

Professional Grade Water Treatments (Continued)



SAB Stream & Pond Cleaner Professional Grade

- Keeps pond water clean and crystal clear
- Reduces pond maintenance
- Reduces ammonia, nitrates
- Phosphate binder

9 lb / 4.08 kg

#30409 MSRP \$267.99

Packaged Weight: 9.5 lb

1 scoop treats 3,000 gal / 11,340 L

1 container treats 45,000 gal / 170,100 L



Waterfall & Rock Cleaner Professional Grade

- Spot-treats the trouble areas on water features
- Quickly eliminates debris from waterfalls and rocks
- Reduces pond maintenance
- Goes to work instantly

9 lb / 4.08 kg

#30413 MSRP \$109.99

Packaged Weight: 9.5lb

1 scoop treats 151-200 sq. ft.

1 container treats 3,650 sq. ft.



Barley Straw Extract Professional Grade

- Natural way to clarify water
- Provides clear, clean pond conditions
- Starts working instantly
- Concentrated formulation with added enzymes

1 gal / 3.78 L

#98906 MSRP \$134.99

Packaged Weight: 9.75 lb

1 scoop treats 6,000 gal / 22,680 L

1 bottle treats 96,000 gal / 362,880 L



Ammonia Neutralizer Professional Grade

- Makes pond water safe for fish and plants
- Detoxifies chloramine in tap water
- Instantly neutralizes large concentrations of toxic ammonia

1 gal / 3.78 L

#40012 MSRP \$134.99

Packaged Weight: 9 lb

1 scoop treats 6,000 gal / 22,680 L

1 bottle treats 96,000 gal / 362,880 L



Pond Detoxifer Professional Grade

- Makes tap water safe for fish and plants
- Removes and detoxifies chlorine and chloramines
- Neutralizes ammonia
- Detoxifies and chelates copper and heavy metals

1 gal / 3.78 L

#30410 MSRP \$134.99

Packaged Weight: 9.5 lb

1 scoop treats 6,000 gal / 22,712 L

1 container treats 96,000 gal / 363,400 L



Sludge & Filter Cleaner Professional Grade

- Biological pond and filter cleaner
- Contains 5 strains of heterotrophic bacteria
- Contains marigold and humic acid

1 gal / 3.78 L

#30408 MSRP \$134.99

Packaged Weight: 9.25 lb

1 scoop treats 6,000 gal / 22,712 L

1 container treats 96,000 gal / 363,400 L

Lake and Large Pond Treatments

Aquascape Lake and Large Pond Treatments are intended for lake and large pond use only. These formulations are optimized specifically for larger bodies of water and can cause issues when used in smaller water features.



Lake Bacteria Packs

- Restores the ecosystem, keeping water clean, clear, and healthy
- Easy-to-use water soluble packs make it easy to treat hard to reach areas
- Significantly reduces maintenance
- Fortified with probiotics to enhance water quality

24 Packs

#40013 MSRP \$107.99

Packaged Weight: 3 lb

Four packs treat ¼ acre for one month
One container treats up to 1.5 acres

48 Packs

#40014 MSRP \$200.99

Packaged Weight: 6.25 lb

Four packs treat ¼ acre for one month
One container treats up to 3 acres

192 Packs

#40015 MSRP \$281.99

Packaged Weight: 25.75 lb

Four packs treat ¼ acre for one month
One container treats up to 12 acres



Lake Bacteria

- Restores the ecosystem, keeping water clean, clear, and healthy
- Significantly reduces maintenance
- Fortified with probiotics to enhance water quality

1 gal

#40016 MSRP \$80.99

Packaged Weight: 9.25 lb

One gallon treats ¼ acre for 1-3 months



Lake Sludge Remover Packs

- Quickly eliminates organic sludge and muck
- Easy-to-use water soluble packs make it easy to spot-treat and treat hard to reach areas
- All active ingredients with no fillers or binders
- Slowly releases oxygen to maximize sludge reduction
- Added macrobiotics and carbon source

192 Packs

#40017 MSRP \$107.99

Packaged Weight: 4.75 lb

One pack treats approximately 250 ft.²
One container treats approximately 48,000 ft.²

384 Packs

#40018 MSRP \$200.99

Packaged Weight: 9.5 lb

One pack treats approximately 250 ft.²
One container treats approximately 96,000 ft.²

1,152 Packs

#40019 MSRP \$468.99

Packaged Weight: 37 lb

One pack treats approximately 250 ft.²
One container treats approximately 288,000 ft.²



Lake Flocculant Clarifier

- Quickly clears cloudy water caused by suspended particles
- Optimized to clarify clay, mineral material, and sediment issues
- Significantly reduces maintenance

1 gal

#40023 MSRP \$107.99

Packaged Weight: 9.25 lb

One gallon treats ¼ acre for 1-3 months

Lake and Large Pond Treatments (Continued)



Lake Blue Dye Packs

- Shades and protects water to prevent/eliminate water quality issues
- Easy-to-use water soluble packs make it easy to treat hard to reach areas
- Significantly reduces maintenance, filters sunlight, and cools water temperature
- Helps hide fish from predators

2 Packs

#40020 MSRP \$33.99

Packaged Weight: .5 lb

One pack treats up to 1.5 acre foot
One container treats up to 3 acre feet

4 Packs

#40021 MSRP \$66.99

Packaged Weight: 1 lb

One pack treats up to 1.5 acre foot
One container treats up to 6 acre feet

16 Packs

#40022 MSRP \$241.99

Packaged Weight: 4.75 lb

One pack treats up to 1.5 acre foot
One container treats up to 24 acre feet



Lake Phosphate Binder Packs

- Quickly binds phosphates to clean and clear water
- Easy-to-use water soluble packs make it easy to treat hard to reach areas
- Prevents and eliminates floating debris and debris that attaches to rocks and gravel
- Significantly reduces maintenance
- Binds orthophosphate

192 Packs

#40024 MSRP \$107.99

Packaged Weight: 5 lb

One pack treats approximately 250 ft.²
One container treats approximately 48,000 ft.²

384 Packs

#40025 MSRP \$200.99

Packaged Weight: 9.25 lb

One pack treats approximately 250 ft.²
One container treats approximately 96,000 ft.²

1,152 Packs

#40026 MSRP \$468.99

Packaged Weight: 29 lb

One pack treats approximately 250 ft.²
One container treats approximately 288,000 ft.²



Lake Treatment Booster Packs

- Turbo boosts the effects of lake water treatments
- Easy-to-use water soluble packs make it easy to spot-treat and treat hard to reach areas
- Adds oxygen and elements directly to the water to accelerate nutrient uptake and sludge digestion
- Increases bacterial growth by up to ten times
- Ideal for use with Lake Sludge Remover Packs, Lake Bacteria Packs, and Lake Phosphate Binder Packs
- Great for non-aerated or highly eutrophic bodies of water

192 Packs

#40027 MSRP \$107.99

Packaged Weight: 4.75 lb

One pack treats approximately 250 ft.²
One container treats approximately 48,000 ft.²

384 Packs

#40028 MSRP \$200.99

Packaged Weight: 9.5 lb

One pack treats approximately 250 ft.²
One container treats approximately 96,000 ft.²

1,152 Packs

#40029 MSRP \$468.99

Packaged Weight: 27.75 lb

One pack treats approximately 250 ft.²
One container treats approximately 288,000 ft.²



PREDATOR CONTROL

Pond fish can be vulnerable to a variety of predators, including large birds such as the pesky blue heron. Fortunately, Aquascape provides several products to help pond owners prevent predators from harming their prized fish. Our popular ornamental deterrents help keep koi and other pond fish safe.



Floating Alligator Decoy

#93000 MSRP \$66.98

Packaged Weight: 2.5 lb

Packaged Dimensions: 11.5"L x 7.5"W x 10"H

Add a little fun to your pond while protecting your valuable fish. The natural body movement will deter herons and other predators from visiting your pond.

- Three hinged body parts allow gator to float freely and appear life-like, deterring pond predators
- Detailed in non-fading, no-glare, all-weather paint



Blue Heron Decoy

#81030 MSRP \$66.98

Packaged Weight: 2.25 lb

Product Dimensions: 28"L x 9"W x 6.25"H

Deter herons from coming to your pond by tricking them into thinking another heron is already there.

- Looks life-like
- Quick and easy set-up
- Hand-painted with non-fading, no-glare, all-weather paint
- Surface treated to prevent paint flaking
- Molded from durable, lightweight polymer



Faux Log Fish Cave

#78324 MSRP \$160.98

Packaged Weight: 11.5 lb

Dimensions: 19"L x 12"W x 10"H

Packaged Dimensions: 22"L x 15"W x 13"H

- Provides pond fish shelter from predators
- Extremely realistic decorative accent for any size pond



SEASONAL CARE

Selecting Your Seasonal Care Products

The following components are vital to ensure that your water feature is properly maintained and your fish are cared for in the colder months of the year.

Cold Water Beneficial Bacteria (for spring and fall) — see page 81 for more information

Beneficial bacteria living in the biological filter and throughout the rocks and gravel in the pond are a key component to achieving crystal clear water and reducing pond maintenance. Aquascape Cold Water Beneficial Bacteria is perfect for both spring and fall because it works at temperatures below 50°F and contains pure strains of concentrated beneficial bacteria that go to work quickly, cleaning and balancing your pond.

Premium Cold Water Fish Food (for spring and fall) — see page 99 for more information

In the colder months of the year, when the water temperature is below 60°F, your fish's metabolism slows down in preparation for hibernation. It is important during these times to either eliminate fish feeding from your daily regimen or switch to Aquascape Premium Cold Water Fish Food. The inclusion of spirulina and wheat germ helps make the food easier to digest in colder water temperatures.

Gas Exchange

In colder months susceptible to freezing conditions, it is important to keep a hole in the ice to ensure proper gas exchange and keep fish safe during cold winter months. This can be accomplished using a variety of products including pond de-icers, AquaForce® pumps, aerators, or the Pond Powerhead.

Protective Pond Netting

Aquascape Protective Pond Netting keeps predators out while catching leaves and falling debris before they enter the pond. The reusable netting is easy to install and resists tearing. Each net comes complete with landscape stakes, making it simple and easy to cover your water feature. In addition to keeping leaves and debris from entering the pond, pond netting also protects fish from predators.



Protective Pond Netting

7' x 10'

#98000 MSRP \$16.98

Packaged Weight: .75 lb

Packaged Dimensions: 5.5"L x 3"W x 9"H

14' x 20'

#98001 MSRP \$29.98

Packaged Weight: 1.1 lb

Packaged Dimensions: 7.25"L x 4.75"W x 15"H

28' x 30'

#98002 MSRP \$79.98

Packaged Weight: 2.5 lb

Packaged Dimensions: 10.5"L x 5"W x 21.5"H

Bulk Protective Pond Netting

Aquascape Bulk Protective Pond Netting is ideal for multiple installations or larger ponds. The easy-to-dispense box and the convenient markers located every five feet make it easy to cut to the proper size. Fine 5/16" mesh keeps out smaller debris.



Bulk Protective Pond Netting

10' x 100'

#74007 MSRP \$133.99

Packaged Weight: 8 lb

Packaged Dimensions: 20"L x 18"W x 10"H

20' x 100'

#74002 MSRP \$281.99

Packaged Weight: 14.5 lb

Packaged Dimensions: 20"L x 18"W x 13"H

30' x 100'

#74003 MSRP \$401.99

Packaged Weight: 20.5 lb

Packaged Dimensions: 21"L x 23"W x 18"H

Bulk Protective Pond Netting Accessories



U-Shaped Ground Stakes

100 pieces

#74008 MSRP \$19.99

Packaged Weight: 1.5 lb

Packaged Dimensions: 7"L x 1.5"W x 8"H

Seasonal Care



Aquascape Seasonal Care products are ideal for the colder, winter months.



300-Watt Pond De-Icer

#39000 MSRP \$189.98

Packaged Weight: 4.5 lb

Packaged Dimensions: 9"L x 9"W x 7"H

Aquascape 300-Watt Pond De-Icer is ideal for keeping a small opening in the ice during cold winter months to ensure proper gas exchange and help keep fish alive during the winter. The de-icer also helps increase pond oxygen levels. The stainless steel construction prevents corrosion and cracking while the built-in LED light indicates when in use.



Features and Benefits

- ① High quality stainless steel housing
- ② LED light indicates when the unit is operating

Circulation and Aeration



Pond Aeration Kits

See page 58 for more information.



Pond Powerhead

See page 51 for more information.



AquaForce® Solids-Handling Pond Pumps

See page 48 for more information.



Cold Water Beneficial Bacteria

See page 81 for more information.



Premium Cold Water Fish Food Pellets

See page 99 for more information.



Submersible Pond Thermometer

#74000 MSRP \$14.98

Packaged Weight: 0.25 lb

Packaged Dimensions: 5"L x 9"W 1"H

Monitor pond temperature throughout the year to adjust fish feeding and water treatment applications during seasonal changes.



FISH CARE

Fish Food

Fish, like all creatures, need healthy, nutrient-rich food to thrive. Aquascape fish foods contain probiotics that aid in digestion, optimize growth rates, and reduce fish waste. Quality ingredients, including multivitamins and stabilized vitamin C, provide superior nutrition and will not break apart and cloud pond water. Aquascape fish foods are scientifically formulated to provide all pond fish, including koi and goldfish, premium quality nutrition at an affordable price.

- Floating pellet ideal for all pond fish
- Includes stabilized multivitamin and probiotics
- Will not break apart and cloud water
- Contains high-quality protein

Nets

Aquascape offers a variety of net options and sizes with both fixed and extendable handles.

Fish Treatments

On occasion, your pond fish may need treatments for illness or wounds. Aquascape offers products that treat parasites, bacterial infections, and fungal infections.

Fish Food



Koi Krunchies

14.1 oz / 400 g

#81000 MSRP \$20.98

Packaged Weight: 1.25 lb

Packaged Dimensions: 6"L x 6"W x 10"H

Aquascape Koi Krunchies are a wonderful addition to your fish's regular diet and are ideal for hand feeding goldfish, koi, and other pond fish. Aquascape Koi Krunchies contain real fruit flavors and are a great source of vitamin C, which is linked to proper tissue formation, proper digestion, and disease resistance.

- Great for hand feeding all pond fish
- Contains quality, natural ingredients



Premium Fish Food Flakes

4.2 oz / 119 g

#98878 MSRP \$20.98

Packaged Weight: .5 lb

Packaged Dimensions: 3.5"L x 3.5"W x 7.5"H

Aquascape Premium Fish Food Flakes are scientifically formulated to provide premium nutrition to all pond fish including goldfish and koi. The inclusion of plankton and shrimp meal help make this food irresistible to pond fish, including smaller fish and babies known as fry.

- Includes stabilized multivitamin
- Will not break apart and cloud water
- Contains high-quality protein
- Promotes brilliant colors on all pond fish



Premium Staple Fish Food Pellets

Formulated for everyday use.

Premium Staple Fish Food Pellets

Item Number	MSRP	Weight	Pellet Size	Recommendation
#98867	\$13.98	1.1 lb / 500 g	Small	Ideal for small fish from 3" (8 cm) and above
#98868	\$20.98	2.25 lb / 1 kg	Small	Ideal for small fish from 3" (8 cm) and above
#98869	\$37.98	4.4 lb / 2 kg	Large	Ideal for large fish from 8" (20 cm) and above
#81049	\$73.98	11 lb / 5 kg	Large	Ideal for large fish from 8" (20 cm) and above
#81007	\$120.98	22 lb / 10 kg	Large	Ideal for large fish from 8" (20 cm) and above
#50003	\$227.98	44 lb / 20 kg	Large	Ideal for large fish from 8" (20 cm) and above
#81050	\$13.98	1.1 lb / 500 g	Mixed	Ideal for all size fish from 3" (8 cm) and above
#81051	\$20.98	2.25 lb / 1 kg	Mixed	Ideal for all size fish from 3" (8 cm) and above
#81052	\$37.98	4.4 lb / 2 kg	Mixed	Ideal for all size fish from 3" (8 cm) and above
#81053	\$73.98	11 lb / 5 kg	Mixed	Ideal for all size fish from 3" (8 cm) and above

Fish Food (Continued)



Premium Cold Water Fish Food Pellets

Formulated to be fed at temperatures as low as 50°F/10°C.

Premium Cold Water Fish Food Pellets

Item Number	MSRP	Weight	Pellet Size	Recommendation
#98870	\$20.98	1.1 lb / 500 g	Small	Ideal for small fish from 3" (8 cm) and above
#98871	\$29.98	2.25 lb / 1 kg	Small	Ideal for small fish from 3" (8 cm) and above
#98872	\$44.98	4.4 lb / 2 kg	Large	Ideal for large fish from 8" (20 cm) and above
#81047	\$93.98	11 lb / 5 kg	Large	Ideal for large fish from 8" (20 cm) and above
#81003	\$174.98	22 lb / 10 kg	Large	Ideal for large fish from 8" (20 cm) and above
#81004	\$321.98	44 lb / 20 kg	Large	Ideal for large fish from 8" (20 cm) and above



Premium Color Enhancing Fish Food Pellets

Formulated to promote brilliant colors for all pond fish.

Premium Color Enhancing Fish Food Pellets

Item Number	MSRP	Weight	Pellet Size	Recommendation
#98873	\$20.98	1.1 lb / 500 g	Small	Ideal for small fish from 3" (8 cm) and above
#98874	\$30.98	2.25 lb / 1 kg	Small	Ideal for small fish from 3" (8 cm) and above
#98875	\$44.98	4.4 lb / 2 kg	Large	Ideal for large fish from 8" (20 cm) and above
#81048	\$93.98	11 lb / 5 kg	Large	Ideal for large fish from 8" (20 cm) and above
#81005	\$174.98	22 lb / 10 kg	Large	Ideal for large fish from 8" (20 cm) and above
#81006	\$334.98	44 lb / 20 kg	Large	Ideal for large fish from 8" (20 cm) and above

Nets

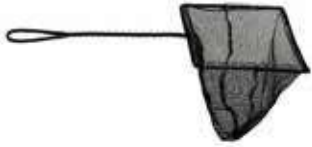

Kid's Pond
Explorer Net

#98556 MSRP \$10.98

Packaged Weight: 0.2 lb

10" x 7" with 12" Handle

Provides a fun way to interact with ponds



Pond Net
with Extendable Handle

#98558 MSRP \$21.98

Packaged Weight: .75 lb

12" x 7" x 32" handle, extends to 63"

For general maintenance and handling pond fish



Pond Skimmer Net
with Extendable Handle

#98559 MSRP \$21.98

Packaged Weight: .75 lb

12" x 7" x 32" handle, extends to 63"

Great for scooping up debris in tight spaces



Collapsible Pond and Fish Net

17" Black Coarse Mesh

#81031 MSRP \$40.98

Packaged Weight: 1.1 lb

For general maintenance and handling fish with collapsible design for easy storage



Collapsible Pond Skimmer Net

17" White Fine Mesh

#81032 MSRP \$40.98

Packaged Weight: 1.1 lb

For quick, easy removal of leaves and debris with collapsible design for easy storage



Pond Shark

#74004 MSRP \$46.98

Packaged Weight: 1.1 lb

Extends up to 60"

Combines three helpful tools into one easy-to-use net for raking, scraping, and collecting algae and debris



Heavy Duty Pond Net with
Extendable Handle

#98560 MSRP \$40.98

Packaged Weight: 1.4 lb

36" handle, extends to 69"

For general maintenance, and handling fish



Heavy Duty Pond Skimmer Net
with Extendable Handle

#98562 MSRP \$40.98

Packaged Weight: 1.4 lb

36" handle, extends to 63"

For removing large amounts of debris



Professional Fish Net with
Extendable Handle

#98561 MSRP \$46.98

Packaged Weight: 2.1 lb

22" diameter head, 32" handle, extends to 69"

For handling and cradling larger pond fish, preventing them from being snagged in mesh



Professional Grade Pond Net

#50000 MSRP \$80.99

Packaged Weight: 2 lb

For handling large fish and general maintenance



Professional Grade Pond
Skimmer Net

#50001 MSRP \$80.99

Packaged Weight: 2 lb

For removing large amounts of debris



Pond Shark Pro

#74005 MSRP \$66.98

Packaged Weight: 1.1 lb

Extends up to 96"

Combines three helpful tools into one easy-to-use net for raking, scraping, and collecting algae and debris

Fish Treatments



Pond Salt

Aquascape Pond Salt reduces the effects of nitrite levels toxic to fish. This treatment helps restore natural electrolytes and repairs natural slime coat. Pond Salt prevents disease in fish.

Pond Salt

2 lb / 0.9 kg

#99416 MSRP \$18.98

Packaged Weight: 2.25 lb

1 scoop treats 190 gal / 718 L

1 container treats up to 1,520 gal / 5,745 L

Pond Salt

9 lb / 4.08 kg

#99417 MSRP \$46.98

Packaged Weight: 10 lb

1 scoop treats 190 gal / 718 L

1 container treats up to 6,840 gal / 25,835 L

Pond Salt

40 lb / 18.16 kg

#40003 MSRP \$66.98

Packaged Weight: 41.5 lb

1 scoop treats 190 gal / 718 L

1 container treats up to 30,400 gal / 114,912 L



AQUATIC PLANT CARE

Aquatic plants are an important part of the water garden. They provide beauty and naturalization with a huge array of plant choices. Most importantly, they help balance the pond's ecosystem and provide valuable biological filtration that removes nitrogen, ammonia, nitrates, and other minerals from pond water. These excess nutrients are often the cause of unsightly water conditions. The end result helps to minimize pond maintenance, leaving more time to enjoy your pond. Without aquatic plants, your pond would not be able to function as a complete ecosystem.

Pond plants can be classified into a few main categories: waterlilies, marginal plants, floating plants, and submerged. Plants can also be put into two basic types known as "tropical" and "hardy." Hardy plants will over-winter in colder climates and tropical plants are more suited to warmer climates, although tropical plants are often used as annuals in colder climate zones.

Aquatic Planters

Aquascape Aquatic Planters are ideal for all pond plants. Made from fine, porous material, the planters allow water in while preventing soil from entering your pond. The flexibility of Aquatic Planters makes it simple to place plants between rocks and other form-fitting areas. Aquatic Planters blend into their surroundings and will not break or crack like traditional plastic planters.



Aquatic Planter 6" x 6"

(2-pack)

#98501 MSRP \$5.98

Packaged Weight: 0.25 lb

Packaged Dimensions: 6.5"L x 7"W x 1"H

Aquatic Planter 8" x 6"

(2-pack)

#98502 MSRP \$6.98

Packaged Weight: 0.25 lb

Packaged Dimensions: 11.5"L x 8"W x 1"H

Aquatic Planter 12" x 8"

(2-pack)

#98500 MSRP \$10.98

Packaged Weight: .5 lb

Packaged Dimensions: 12"L x 8"W x .5"H

Aquatic Lily Planter 14" x 7"

(2-pack)

#98929 MSRP \$12.98

Packaged Weight: .5 lb

Packaged Dimensions: 12"L x 9.5"W x 1"H

Floating Plant Island

The Aquascape Floating Plant Island is ideal for displaying plants in deeper areas of the pond or where there are no plant shelves. The floating planter is constructed to stay afloat at the surface of the pond and keeps the soil intact and lets water in while protecting plants from fish.



Floating Plant Island

#89006 MSRP \$37.98

Packaged Weight: .5 lb

Dimensions: 15"L x 11"W x 4"H

Packaged Dimensions: 16"L x 4"W x 12.5"H

Pond Plant Potting Media

This all-natural, non-toxic alluvial planting media is fine-grained and perfect for supporting the growth of aquatic plants. Our premium potting media contains no peat moss or compost and is safe for fish.



Pond Plant Potting Media

215 cubic inches / 0.0035 cubic meters

#89002 MSRP \$13.98

Pond Plant Potting Media

432 cubic in / 0.007 cubic meters

#89003 MSRP \$24.98



DECORATIVE

Decorative Water Features

Decorative water features include Fire Fountains, container water gardens, bubbling rocks or urns, spitters, and more.

Fire Fountains

Fire Fountains combine the beauty and elegance of fire and flowing water in a durable, self-contained GFRC (glass fiber reinforced concrete) water feature that sets up in minutes.

Container Water Gardens

Container water gardens are great for people who do not have the space or budget for an ecosystem pond, providing a way to add a miniature pond to any location.

Decorative Spitters

Decorative spitters are often used to add a whimsical touch or create a focal point and water movement to existing ponds or container water gardens. Decorative spitters can also be incorporated into traditional landscapes when combined with a small reservoir.

Urns, Bubbling Stones, and More

These water features are typically set atop an underground reservoir known as an AquaBasin®. A water pump contained within the AquaBasin keeps circulating the water over the feature.

Fire Fountains

The Aquascape Fire Fountain provides the beauty and elegance of fire and flowing water in a bowl-shaped GFRC water feature. The self-contained water feature is a complete kit and sets up in minutes. Simply connect the included pump and plumbing, fill with water, and enjoy! The fire feature in the center makes this fountain an ideal focal point or centerpiece to any outdoor setting. Paraffin oil recommended (not included).



Fire Fountain 24"

#78201 MSRP \$559.98

Packaged Weight: 56 lb

Dimensions: 24" diameter x 12"H

Packaged Dimensions: 26.5"L x 26.5"W x 14"H



Fire Fountain 28"

#78202 MSRP \$719.98

Packaged Weight: 72 lb

Dimensions: 28" diameter x 14"H

Packaged Dimensions: 30.5"L x 30.5"W x 17"H



Fire Fountain 32"

#78203 MSRP \$869.98

Packaged Weight: 96 lb

Dimensions: 32" diameter x 16"H

Packaged Dimensions: 34.5"L x 34.5"W x 18.25"H

Fire Glass



1/4" Reflective Black
Fire Glass

#78262 MSRP \$107.98

Packaged Weight: 10.5 lb

Packaged Dimensions: 6.25"L x 5"W x 9"H



1/4" Reflective Cobalt Blue
Fire Glass

#78263 MSRP \$107.98

Packaged Weight: 10.5 lb

Packaged Dimensions: 6.25"L x 5"W x 9"H



1/4" Aquamarine
Fire Glass

#78264 MSRP \$107.98

Packaged Weight: 10.5 lb

Packaged Dimensions: 6.25"L x 5"W x 9"H

Fire Fountain Add-On Kits

Add the element of fire to a select group of our fountains with a plug-and-play Fire Fountain Add-On Kit.



Fire Fountain Add-On Kit
for Stacked Slate Fountains

#78221 MSRP \$129.98

Packaged Weight: 4.5 lb

Packaged Dimensions: 10.5"L x 10.5"W x 7.5"H



Fire Fountain Add-On Kit
for Scalloped Urns

#78260 MSRP \$129.98

Packaged Weight: 4.5 lb

Packaged Dimensions: 10.5"L x 10.5"W x 7.5"H



Fire Fountain Add-On Kit
for Rippled Urns

#78267 MSRP \$129.98

Packaged Weight: 4.5 lb

Packaged Dimensions: 10.5"L x 10.5"W x 7.5"H

AquaGarden Mini Pond Kit

NEW

Add a small pond and water garden to any outdoor or indoor location with the Aquascape AquaGarden Mini Pond Kit. This complete kit includes everything you need to get started, simply add your favorite plants and watch them grow. Great plant additions to the upper water garden include some houseplants, herbs, marginal plants, and more. The lower pond area holds 5 to 7 gallons of water and is a great place for floating plants, a small water lily, or even a few small fish to create a recirculating aquaponics system.



AquaGarden Mini Pond Kit

#78325 MSRP \$269.98

Packaged Weight: 19 lbs

Packaged Dimensions: 24"L x 24"W x 14"H

Kit Includes:

- AquaGarden Mini Pond
- Plant and waterfall filter
- Waterfall light
- Water pump with low-suction attachment
- Expanded clay grow media
- (2) Decorative gravel



Features and Benefits

- ① Durable, injection-molded container is lightweight and built to last
- ② Integrated plant and waterfall filter cleans water and houses plants
- ③ Pump with low-suction attachment maximizes water usage and circulation
- ④ Integrated waterfall light illuminates the waterfall
- ⑤ Expanded clay grow media provides an ideal environment for plant growth
- ⑥ Decorative gravel in upper waterfall weighs down and disguises the grow media
- ⑦ Decorative gravel in lower pond beautifies the pond and provides surface area for beneficial bacteria to help keep the water clean

Aquatic Patio Pond Kit

The Aquascape Aquatic Patio Pond Kit makes it easy to add the soothing sounds of water to any location. Use in your garden, on your deck, patio, or balcony, or take it inside and add the beauty of water to your desk, kitchen, or living room.



Aquatic Patio Pond Kit

#78197 MSRP \$249.98

Packaged Weight: 9 lb

Packaged Dimensions: 19"L x 19"W x 10.5"H

Kit Includes:

- 16" Square Textured Gray Slate Patio Pond
- Pouring Bamboo Fountain with pump

Patio Ponds

Aquascape Patio Ponds make it simple to have a complete water garden in almost any setting. Creating a beautifully planted container water garden has never been easier. Use outside in your outdoor living space or bring indoors to add the soothing sounds of water to any room. Aquascape Patio Ponds have all the natural beauty of real stone with the added durability and light weight of fiberglass. The natural rock veneer never fades or chips and ages like real stone. The integrated plant shelf makes it easy to create a natural paradise with Aquascape Patio Ponds.



Green Slate 24"
Patio Pond
10 gallons

#98853 MSRP \$279.98

Packaged Weight: 28 lb

Dimensions: 24"L x 24"W x 12"H

Green Slate 32"
Patio Pond
20 gallons

#98856 MSRP \$429.98

Packaged Weight: 43.5 lb

Dimensions: 32"L x 32"W x 14"H

Green Slate 40"
Patio Pond
30 gallons

#98859 MSRP \$589.98

Packaged Weight: 51 lb

Dimensions: 40"L x 40"W x 16"H



Desert Granite 24"
Patio Pond
10 gallons

#98854 MSRP \$279.98

Packaged Weight: 28 lb

Dimensions: 24"L x 24"W x 12"H

Desert Granite 32"
Patio Pond
20 gallons

#98857 MSRP \$429.98

Packaged Weight: 43.5 lb

Dimensions: 32"L x 32"W x 14"H

Desert Granite 40"
Patio Pond
30 gallons

#98860 MSRP \$589.98

Packaged Weight: 51 lb

Dimensions: 40"L x 40"W x 16"H



European Terra Cotta 24"
Patio Pond
10 gallons

#98855 MSRP \$279.98

Packaged Weight: 28 lb

Dimensions: 24"L x 24"W x 12"H

European Terra Cotta 32"
Patio Pond
20 gallons

#98858 MSRP \$429.98

Packaged Weight: 43.5 lb

Dimensions: 32"L x 32"W x 14"H

European Terra Cotta 40"
Patio Pond
30 gallons

#98861 MSRP \$589.98

Packaged Weight: 51 lb

Dimensions: 40"L x 40"W x 16"H



Textured Gray Slate 22"
Patio Pond
15 gallons

#78049 MSRP \$279.98

Packaged Weight: 28 lb

Dimensions: 22"L x 22"W x 12"H

Textured Gray Slate 27"
Patio Pond
27 gallons

#78050 MSRP \$429.98

Packaged Weight: 43.5 lb

Dimensions: 27"L x 27"W x 14"H

Textured Gray Slate 33"
Patio Pond
45 gallons

#78051 MSRP \$589.98

Packaged Weight: 34.5 lb

Dimensions: 33"L x 33"W x 16"H

Bamboo Spitters

Aquascape Bamboo Spitters are made from high quality, sturdy, polyresin that is both lightweight and UV and heat resistant. Polyresin takes on the texture, shape, and finish of real bamboo at a fraction of the cost and maintenance.



Deer Scarer
Bamboo Fountain

#78306 MSRP \$93.98

Packaged Weight: 4.25 lb

Packaged Dimensions: 18"L x 7"W x 8"H

Recommended: 90 GPH Water Pump #91024



Pouring 3-Tier
Bamboo Fountain

#78307 MSRP \$79.98

Packaged Weight: 3.25 lb

Packaged Dimensions: 18.5"L x 7.25"W x 7.5"H

Recommended: 90 GPH Water Pump #91024



Adjustable Pouring
Bamboo Fountain

#78308 MSRP \$93.98

Packaged Weight: 5.75 lb

Packaged Dimensions: 22.25"L x 7.5"W x 9"H
Fountain Extends from 18" to 30"

Recommended: 90 GPH Water Pump #91024

Decorative Spitters

Aquascape Decorative Spitters are made from high quality, sturdy, polyresin that is both lightweight and UV and heat resistant. Polyresin takes on the texture, shape, and finish of real brass, wood, and stone at a fraction of the cost and maintenance.



Alligator Spitter

#78302 MSRP \$174.98

Packaged Weight: 9.75 lb

Packaged Dimensions: 21.75"L x 14"W x 14"H

Recommended: 180 GPH Water Pump #91025



Dragonfly Spitter

#78303 MSRP \$199.98

Packaged Weight: 14.5 lb

Packaged Dimensions: 27.5"L x 19.25"W x 14.5"H

Recommended: 180 GPH Water Pump #91025



Double Frog with Cattail Spitter

#78304 MSRP \$174.98

Packaged Weight: 9.5 lb

Packaged Dimensions: 10"L x 10"W x 18"H

Recommended: 180 GPH Water Pump #91025



Frog on Reed Spitter

#78305 MSRP \$174.98

Packaged Weight: 6.75 lb

Packaged Dimensions: 20"L x 17.5"W x 12"H

Recommended: 80 GPH Water Pump #91025



Lazy Frog on Lily Pad Spitter

#78311 MSRP \$79.98

Packaged Weight: 4.25 lb

Packaged Dimensions: 13"L x 12"W x 7.5"H

Recommended: 90 GPH Water Pump #91024



Naughty Dog Spitter

#78310 MSRP \$119.98

Packaged Weight: 8.5 lb

Packaged Dimensions: 20.5"L x 12"W x 12.75"H

Recommended: 90 GPH Water Pump #91024



Crazy Legs Frog Spitter

#78312 MSRP \$174.98

Packaged Weight: 10 lb

Packaged Dimensions: 40"L x 11.5"W x 22"H

Recommended: 90 GPH Water Pump #91024



Crane with Lowered Head Spitter

#78313 MSRP \$259.98

Packaged Weight: 17.25 lb

Packaged Dimensions: 22.5"L x 14.25"W x 37.5"H

Recommended: 180 GPH Water Pump #91025



Standing Crane Spitter

#78314 MSRP \$259.98

Packaged Weight: 18.25 lb

Packaged Dimensions: 19.5"L x 14"W x 44"H

Recommended: 180 GPH Water Pump #91025



Toucan Spitter

#78309 MSRP \$174.98

Packaged Weight: 10.25 lb

Packaged Dimensions: 19"L x 12.5"W x 19.5"H

Recommended: 90 GPH Water Pump #91024



Man in Barrel Spitter

#78315 MSRP \$79.98

Packaged Weight: 3.75 lb

Package Dimensions: 12"L x 9"W x 14.5"H

Head Dimensions: 8.5"L x 11"W x 8"H

Hand Dimensions: 4.5"L x 5"W x 3"H

Recommended: 90 GPH Water Pump #91024



* barrel not included

Decorative Accessories



Decorative River Pebbles— Black

#78160 MSRP \$33.98

Packaged Weight: 22 lb

Packaged Dimensions: 9"L x 3.5"W x 14"H

- Each stone measures approximately 3 to 5" in size, each bag covers 1.5 square surface feet



Decorative River Pebbles— Mixed

#78161 MSRP \$33.98

Packaged Weight: 22 lb

Packaged Dimensions: 9"L x 3.5"W x 14"H

- Each stone measures approximately 3 to 5" in size, each bag covers 1.5 square surface feet



Fountain Shims (set of 6)

#78159 MSRP \$9.98

Packaged Weight: .5 lb

Packaged Dimensions: 4"L x 1"W x 7"H

- Ideal for leveling resin, concrete, stone, or GFRC water fountains.



NEW



Faux Log Fish Cave

#78324 MSRP \$160.98

Packaged Weight: 11.5 lb

Dimensions: 19"L x 12"W x 10"H

Packaged Dimensions: 22"L x 15"W x 13"H

- Provides pond fish shelter from predators
- Extremely realistic decorative accent for any size pond



Faux Oak Stump Cover

#78259 MSRP \$174.98

Packaged Weight: 19 lb

Dimensions: 15" diameter x 18.5"H

Packaged Dimensions: 18"L x 18"W x 21"H

- Great for hiding outdoor electrical outlets
- Can also be used as a decorative garden accent or seat



Faux Driftwood 30"

#78276 MSRP \$80.98

Packaged Weight: 4.5 lb

Packaged Dimensions: 31.75"L x 7"W x 10.5"H

- Ideal for concealing hard-to-hide water feature components
- Great for use as a decorative accent



Faux Driftwood 35"

#78277 MSRP \$100.98

Packaged Weight: 7.5 lb

Packaged Dimensions: 36"L x 8"W x 10.75"H

- Ideal for concealing hard-to-hide water feature components
- Great for use as a decorative accent

Water Feature Basins

The Aquascape AquaBasins® are engineered to provide a trouble-free, easy-to-install fountain basin for a wide variety of decorative water feature installations, including natural stone, brass, and resin fountains. Their innovative design provides features and benefits that eliminate guesswork, improve water circulation, increase accessibility, and ensure a lifetime of enjoyment.



AquaBasin® 45
#78224 MSRP \$579.98
 Packaged Weight: 60 lb



AquaBasin® 30
#78223 MSRP \$389.98
 Packaged Weight: 22 lb



AquaBasin® Medium
#76004 MSRP \$409.98
 Packaged Weight: 8.5 lb



DecoBasin
#60000 MSRP \$134.98
 Packaged Weight: 9 lb

- 5" diameter pump access hole
- 54" splash skirt prevents leakage or over-splash

Comparison Chart

Model	AquaBasin 45	AquaBasin 30	AquaBasin Medium	DecoBasin
Water Storage Capacity	98 gal	27 gal	40 gal	15 gal
Max Flow Rate	4,000 GPH	2,000 GPH	2,000 GPH	1,500 GPH
Dimensions	44.5"L x 44.5"W x 16"H	30"L x 30"W x 12"H	24"L x 24"W x 16"H	22" diameter x 14.25"H
Weight Capacity	1,500 lb	500 lb	1,200 lb	100 lb
Warrenty	Lifetime	Limited	Lifetime	1-Year

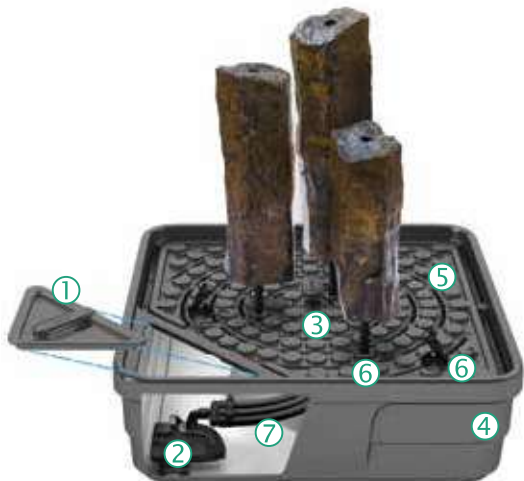

Features and Benefits of the AquaBasin® 45 and 30

- ① Large corner pump access panel fits larger pumps and sits elevated to prevent gravel from falling into the basin
- ② Pump and valve controls are easy to access for maintenance and adjusting water flow
- ③ Large, flat deck design makes it easy to set and position fountains
- ④ Professional-grade, high-density polyethylene construction
- ⑤ Drainage slots throughout the deck maximize water circulation
- ⑥ Structural deck cylinders provide endless plumbing and lighting port configurations, while reinforcing basin strength
- ⑦ Internal plumbing support allows plumbing to sit below the deck as it travels to the fountain(s), making installation simple and keeping plumbing out of sight

Stacked Slate Spheres



Small Stacked Slate Sphere

#78287 MSRP **\$499.98**

Packaged Weight: 26 lb

Dimensions: 24" diameter x 22"H

Recommended Pump:

Ultra 800 Water Pump #91007

Medium Stacked Slate Sphere

#78288 MSRP **\$849.98**

Packaged Weight: 68 lb

Dimensions: 32" diameter x 30"H

Recommended Pump:

Ultra 1500 Water Pump #91009

Large Stacked Slate Sphere

#78289 MSRP **\$1,339.98**

Packaged Weight: 111 lb

Dimensions: 40" diameter x 37.5"H

Recommended Pump:

Ultra 2000 Water Pump #91010



Fire Fountain Add-On Kit for Stacked Slate Fountains

#78221 MSRP **\$129.98**

Packaged Weight: 5.5 lb

Packaged Dimensions: 10.5"L x 10.5"W x 7.5"H



Medium Stacked Slate Sphere Landscape Fountain Kit

#78290 MSRP **\$1,599.98**

Packaged Weight: 195 lb

See page 20 for more information.

Stacked Slate Walls

1. Choose a base.
2. Choose a topper.
3. Mix and match toppers and bases, linking them together to create beautiful, customized designs!

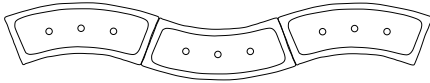

Create an S-Curve

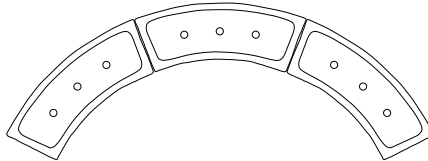

Create a Crescent

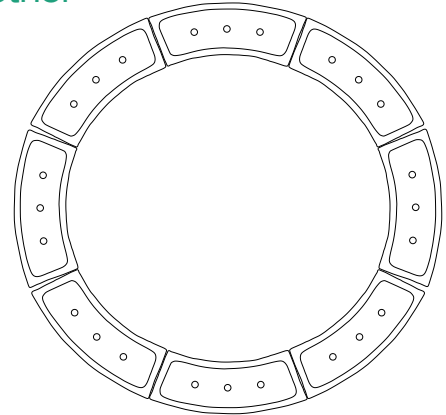

Create a Circle

Curved Stacked Slate Wall Toppers



Front-Spill
Curved Stacked Slate Topper

#78284 MSRP \$269.98

Packaged Weight: 19.25 lb

Dimensions: 36"L x 12"W x 6"H



Rear-Spill
Curved Stacked Slate Topper

#78285 MSRP \$269.98

Packaged Weight: 17.5 lb

Dimensions: 36"L x 12"W x 6"H



Quad-Spill
Curved Stacked Slate Topper

#78286 MSRP \$269.98

Packaged Weight: 19.25 lb

Dimensions: 36"L x 12"W x 6"H

Curved Stacked Slate Wall Bases



Small Curved Stacked Slate Wall Base

#78283 MSRP \$429.98

Packaged Weight: 22.75 lb

Dimensions: 36"L x 12"W x 13"H

Recommended Pump:

Ultra 2000 Water Pump #91010



Large Curved Stacked Slate Wall Base

#78282 MSRP \$619.98

Packaged Weight: 39 lb

Dimensions: 36"L x 12"W x 26"H

Recommended Pump:

Ultra 2000 Water Pump #91010

Straight Stacked Slate Wall Toppers



Quad-Spill
Straight Stacked Slate Topper

#78280 MSRP \$269.98

Packaged Weight: 18.75 lb

Dimensions: 36"L x 12"W x 6"H



Front-Spill
Straight Stacked Slate Topper

#78281 MSRP \$269.98

Packaged Weight: 18.75 lb

Dimensions: 36"L x 12"W x 6"H

Straight Stacked Slate Wall Bases



Small Straight Stacked Slate Wall Base

#78279 MSRP \$429.98

Packaged Weight: 24 lb

Dimensions: 36"L x 12"W x 13"H

Recommended Pump:

Ultra 2000 Water Pump #91010



Large Straight Stacked Slate Wall Base

#78278 MSRP \$619.98

Packaged Weight: 41 lb

Dimensions: 36"L x 12"W x 26"H

Recommended Pump:

Ultra 2000 Water Pump #91010



Stacked Slate Spillway Wall 32"
Landscape Fountain Kit

#78269 MSRP \$1,699.98

Packaged Weight: 157 lb

See page 20 for more information.

Stacked Slate Urns



Small Stacked Slate Urn

#98939 MSRP \$499.98

Packaged Weight: 34.5 lb

Dimensions: 21.25" diameter x 33.5"H

Recommended Pump:

Ultra 550 Water Pump #91006

Medium Stacked Slate Urn

#78207 MSRP \$849.98

Packaged Weight: 56 lb

Dimensions: 27" diameter x 45"H

Recommended Pump:

Ultra 1100 Water Pump #91008

Large Stacked Slate Urn

#98940 MSRP \$1,339.98

Packaged Weight: 104 lb

Dimensions: 35.5" diameter x 55"H

Recommended Pump:

Ultra 2000 Water Pump #91010



Small Stacked Slate Urn Fountain Kit

#58064 MSRP \$699.98

Packaged Weight: 38 lb

Kit Includes: Small Stacked Slate Urn, tubing, DecoBasin, and Ultra 550 Water Pump



Medium Stacked Slate Urn Landscape Fountain Kit

#58090 MSRP \$1,599.98

Packaged Weight: 180 lb

See page 20 for more information.



Fire Fountain Add-On Kit for Stacked Slate Fountains

#78221 MSRP \$129.98

Packaged Weight: 5.5 lb

Packaged Dimensions: 10.5"L x 10.5"W x 7.5"H

Scalloped Urns



Small Scalloped Urn

#78238 MSRP \$499.98

Packaged Weight: 26 lb

Dimensions: 20" diameter x 32"H

Recommended Pump:

Ultra 550 Water Pump #91006

Medium Scalloped Urn

#78239 MSRP \$849.98

Packaged Weight: 50 lb

Dimensions: 27" diameter x 45"H

Recommended Pump:

Ultra 1100 Water Pump #91008

Large Scalloped Urn

#78240 MSRP \$1,339.98

Packaged Weight: 93 lb

Dimensions: 38" diameter x 56"H

Recommended Pump:

Ultra 2000 Water Pump #91010

Scalloped Urns (Continued)



Medium Scalloped Urn
Landscape Fountain Kit

#78270 MSRP \$1,599.98

Packaged Weight: 145 lb

See page 20 for more information.



Fire Fountain Add-On Kit
for Scalloped Urns

#78260 MSRP \$129.98

Packaged Weight: 5.5 lb

Packaged Dimensions: 10.5"L x 10.5"W x 7.5"H

Rippled Urns



Small Rippled Urn

#78241 MSRP \$499.98

Packaged Weight: 24.7 lb

Dimensions: 20" diameter x 32"H

Recommended Pump:

Ultra 550 Water Pump #91006

Medium Rippled Urn

#78242 MSRP \$849.98

Packaged Weight: 42 lb

Dimensions: 27" diameter x 45"H

Recommended Pump:

Ultra 1100 Water Pump #91008

Large Rippled Urn

#78243 MSRP \$1,339.98

Packaged Weight: 91 lb

Dimensions: 38" diameter x 56"H

Recommended Pump:

Ultra 2000 Water Pump #91010



Medium Rippled Urn
Landscape Fountain Kit

#78271 MSRP \$1,599.98

Packaged Weight: 164 lb

See page 20 for more information.



Fire Fountain Add-On Kit
for Rippled Urns

#78267 MSRP \$129.98

Packaged Weight: 5.5 lb

Packaged Dimensions: 10.5"L x 10.5"W x 7.5"H

Spillway Bowl, Basin, and Stand

The Aquascape Spillway Bowl, Basin, and Stand have a beautiful and unique patina made from durable GFRC (glass fiber reinforced concrete). They are lightweight and easy to install in unlimited possibilities. Install them as a disappearing water feature or link several together for an inspired display. The stands create the ideal elevation between the bowl and basin.



Spillway Basin 40"

#78205 MSRP \$609.98

Packaged Weight: 119 lb

Dimensions: 40"L x 40"W x 16"H

Recommended Pump:

Ultra 2000 Water Pump #91010



Spillway Bowl 32"

#78204 MSRP \$409.98

Packaged Weight: 70.25 lb

Dimensions: 32"L x 32"W x 14.5"H

Recommended Pump:

Ultra 2000 Water Pump #91010



Spillway Bowl Stand

(2-pack)

#78206 MSRP \$109.98

Packaged Weight: 33.5 lb

Dimensions: 13.5"L x 13.5"W x 4"H



Spillway Bowl and Basin
Landscape Fountain Kit

#58087 MSRP \$1,899.98

Packaged Weight: 380 lb

See page 20 for more information.

Pagoda Fountain Rocks

These beautiful, stratified limestone rocks have incredible foliation and one-of-a-kind shape and character that provide a beautiful rippling effect as water cascades over the surface of the stones.



Pagoda Fountain Rocks Set of 3

#78219 MSRP \$1,209.98

Approx. Packaged Weight: 482 lb

Recommended Pump:

Ultra 2000 Water Pump #91010



Pagoda Fountain Rocks Set of 3
Landscape Fountain Kit

#58086 MSRP \$1,999.98

Approx. Packaged Weight: 594 lb

See page 20 for more information.

Stone Basalt Columns

These natural stones provide impressive sights and sounds as water tumbles from the tall columns. The amazing variation and texture options ensure there is a basalt column perfect for any location.



Natural Mongolian Basalt Column 24"

#58038 MSRP **\$429.98**

Approx. Packaged Weight: 200 lb
Dimensions: 10" diameter x 24"H

Recommended Pump:
Ultra 550 Water Pump #91006

Natural Mongolian Basalt Column 30"

#98503 MSRP **\$499.98**

Approx. Packaged Weight: 335 lb
Dimensions: 10" diameter x 30"H

Recommended Pump:
Ultra 1100 Water Pump #91008

Natural Mongolian Basalt Column 36"

#98969 MSRP **\$569.98**

Approx. Packaged Weight: 375 lb
Dimensions: 10" diameter x 36"H

Recommended Pump:
Ultra 2000 Water Pump #91010



Natural Mongolian Basalt Columns Set of 3

#58062 MSRP **\$1,339.98**

Packaged Weight: 850 lb
(1) 24", (1) 30", (1) 36"



Mongolian Basalt Columns Set of 3 Landscape Fountain Kit

#58089 MSRP **\$2,099.98**

Approx. Packaged Weight: 970 lb
[See page 20 for more information.](#)



Mongolian Basalt Column 30" Landscape Fountain Kit

#58065 MSRP **\$1,199.98**

Approx. Packaged Weight: 388 lb
[See page 20 for more information.](#)



Double-Textured Basalt Columns Set of 3

#98548 MSRP **\$749.98**

Packaged Weight: 276 lb

Includes:
(1)—9" diameter x 20"H
(1)—7" diameter x 13"H
(1)—8" diameter x 8"H

Recommended:
AquaBasin® 30 #78223
Ultra 1100 Water Pump #91008
Kink-Free Pipe ¾" x 6' #98404



Keyed Basalt Columns Set of 3

#98552 MSRP **\$749.98**

Packaged Weight: 246 lb

Includes:
(1)—11" diameter x 18"H
(1)—11" diameter x 12"H
(1)—10" diameter x 6"H

Recommended:
AquaBasin® 30 #78223
Ultra 400 Water Pump #91005
Kink-Free Pipe ¾" x 6' #98404



Semi-Polished Stone Basalt Columns Set of 3

#98264 MSRP **\$1,209.98**

Packaged Weight: 289 lb

Includes:
(1)—7.5" diameter x 12"H
(1)—7.5" diameter x 20"H
(1)—10" diameter x 27"H

Recommended:
AquaBasin® 45 #78224
Ultra 2000 Water Pump #91010
Kink-Free Pipe ¾" x 6' #98404

Backyard Waterfall Landscape Fountain Kit

The Aquascape Backyard Waterfall Landscape Fountain Kit is the perfect, easy-to-install Pondless® Waterfall kit. This complete kit includes the necessary components to install the soothing sound of running water to almost any outdoor location. Perfect for smaller spaces, this kit is ideal for front yards or situated next to your patio.



Backyard Waterfall Landscape Fountain Kit

#83013 MSRP \$1,199.98

Packaged Weight: 175 lb

Packaged Dimensions: 48"L x 40"W x 35"H (Palletized)

Kit Includes:

- Waterfall Spillway
- AquaBasin® 45
- Pre-cut EPDM Liner—7.5' x 7.5'
- Flexible PVC Pipe—1.5" x 15'
- AquaSurge® 2000 Pond Pump
- AquaSurge® Low Suction Intake Attachment
- Installation Kit
 - Fittings
 - Silicone Sealant
 - Pond and Waterfall Foam Sealant
- Welcome Kit

Backyard Waterfall Landscape Fountain Kit Application

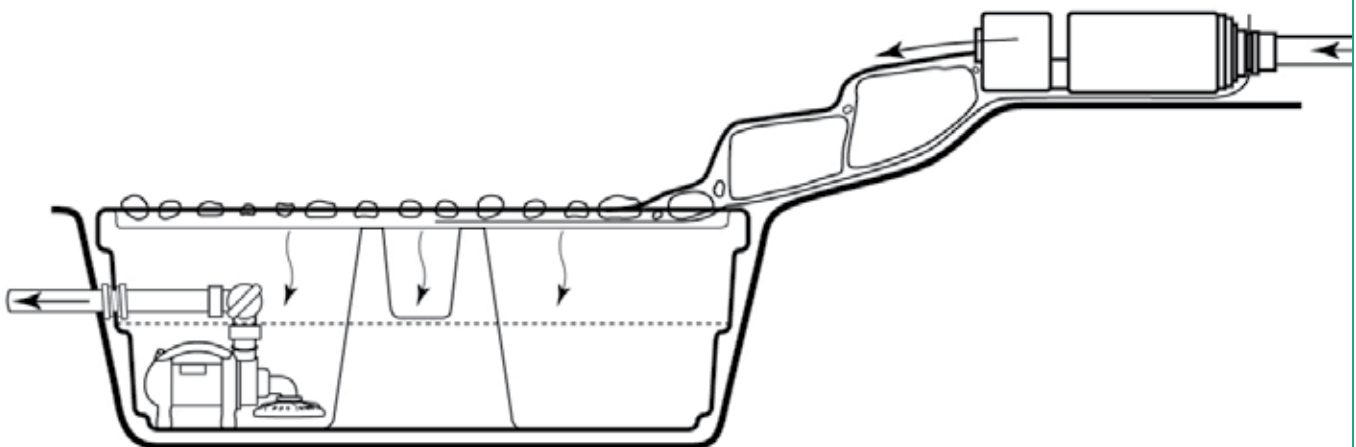

Stainless Steel WaterWall Spillway

Incorporate beautiful, low-maintenance formal waterfalls into any design using the Aquascape Stainless Steel WaterWall Spillway.



Stainless Steel WaterWall Spillway

#58066 MSRP \$319.99

Packaged Weight: 6.75 lb

Packaged Dimensions: 16.5"L x 5"W x 9.5"H

Kit Includes:

- Stainless steel construction for strength and corrosion resistance
- Clog-free, open-top design reduces maintenance
- 16" wide spillway and 1" plumbing port handles pumps up to 2,000 GPH



Stainless Steel WaterWall Spillway Kit

#58080 MSRP \$1,149.99

Packaged Weight: 40 lb

Kit Includes:

- Stainless Steel Waterfall Spillway (16")
- AquaBasin® Medium with splash pad
- Ultra Pump with plumbing components
- Garden and Pond 1-Watt LED Waterfall and Up Light
- Garden and Pond 6-Watt 12V Quick-Connect Transformer
- Compact Water Fill Valve

AquaRock Fountain Kits

Incorporate the sights and sounds of water into any location with Aquascape AquaRock Fountain Kits. Kits are available in two colors and come complete with everything needed to install a beautiful water fountain. Simple to install and maintain, these fountain kits integrate easily into existing landscapes. Made from real rock, AquaRocks are hand crafted and made in the USA.



AquaRock Sandstone Fountain Kit

#97068 MSRP \$79.98

Packaged Weight: 52 lb

Packaged Dimensions: 12" diameter x 14"H

Kit Includes:

- Five gallon bucket (water basin) and perforated lid
- Lid liner skirt
- Water pump with 6' power cord
- Water hose
- Drilled sandstone rock



AquaRock Blue Stone Fountain Kit

#97067 MSRP \$79.98

Packaged Weight: 52 lb

Packaged Dimensions: 12" diameter x 14"H

Kit Includes:

- Five gallon bucket (water basin) and perforated lid
- Lid liner skirt
- Water pump with 6' power cord
- Water hose
- Drilled blue stone rock



LINER, UNDERLAYMENT, AND GEOTEXTILE

Liner, underlayment, and geotextile are the pond's foundation. With a large selection of liners available, it is important to always determine whether the liner you choose is safe for fish that may inhabit the pond.

Aquascape 45 mil fish-safe EPDM pond liner leads the industry in quality and reliability. Backed by an industry leading 20-year guarantee, Aquascape pond liner is the choice of discerning pond professionals. With superior elongation and lay-flat characteristics, it installs easily with no special tools required. Aquascape 45 mil EPDM Liner also has exceptional resistance to solar UV, ozone, and oxidation.

Underlayment is installed before the liner to prevent punctures from rough or rocky ground. Not only does underlayment provide protection for the liner, it also allows the ground to breathe from underneath. The fabric allows the earth's gases to escape from underneath the liner rather than becoming trapped, causing gas bubbles to push the liner up into the pond.



45 mil EPDM Liner

45 mil EPDM Liner Rolls*			
Item #	MSRP	Roll Dimensions	Packaged Weight
#42002	\$745.00	5' x 100'	162 lb
#29188	\$745.00	10' x 50'	162 lb
#29189	\$1,490.00	10' x 100'	324 lb
#29192	\$1,117.50	15' x 50'	243 lb
#29193	\$2,235.00	15' x 100'	486 lb
#29196	\$1,490.00	20' x 50'	324 lb
#29197	\$2,980.00	20' x 100'	648 lb
#29200	\$1,862.50	25' x 50'	402 lb
#29201	\$3,725.00	25' x 100'	810 lb
#29202	\$2,235.00	30' x 50'	486 lb
#29203	\$4,470.00	30' x 100'	972 lb
#29206	\$2,980.00	40' x 50'	678 lb
#29207	\$5,960.00	40' x 100'	1,295 lb
#29210	\$3,725.00	50' x 50'	810 lb
#29211	\$7,450.00	50' x 100'	1,619 lb

45 mil EPDM Liner Mini Rolls			
Item #	MSRP	Roll Dimensions	Packaged Weight
#42018	\$745.00	20' x 25'	162 lb
#42019	\$894.00	20' x 30'	195 lb
#42020	\$1,117.50	25' x 30'	243 lb
#42021	\$1,341.00	30' x 30'	292 lb

45 mil EPDM Boxed Liner				
Item #	MSRP	Liner Dimensions	Packaged Dimensions	Packaged Weight
#85009	\$119.20	8' x 10'	12"L x 12"W x 12"H	23 lb
#29607	\$149.00	10' x 10'	20"L x 15.5"W x 9.5"H	29.5 lb
#85000	\$178.80	10' x 12'	16"L x 11"W x 14.5"H	33 lb
#29612	\$298.00	10' x 20'	20"L x 16"W x 13"H	65 lb
#29616	\$447.00	10' x 30'	17.5"L x 24"W x 14"H	65 lb
#85001	\$268.20	12' x 15'	18"L x 11.5"W x 14.5"H	50 lb
#85002	\$335.25	15' x 15'	20"L x 25.5"W x 15"H	70 lb
#85003	\$447.00	15' x 20'	19"L x 17"W x 19"H	90 lb
#85004	\$745.00	20' x 25'	21"L x 18"W x 22"H	152 lb

* Larger roll lengths of 150' and 200' available. Call for availability!

Additional Liner and Underlayment

36 mil Reinforced Polypropylene Liner			
Item #	MSRP	Roll Dimensions	Packaged Weight
#30336	CALL FOR PRICE	Special Order Only • Minimum Size of 50' x 100'	0.185 lb per sq. ft.

Boxed Non-Woven Geotextile Underlayment				
Item #	MSRP	Underlayment Dimensions	Packaged Dimensions	Packaged Weight
#85010	\$66.98	10' x 15'	13"L x 12"W x 12"H	5.7 lb

Non-Woven Geotextile Underlayment Rolls			
Item #	MSRP	Roll Dimensions	Packaged Weight
#30300	\$442.99	5' x 300'	59 lb
#29169	\$1,169.99	15' x 300'	200 lb
#29170	\$1,169.99	7.5' x 600'	175 lb
#29227	\$0.54	Cut to Size	0.04 lb per sq. ft. over 900 sq. ft.

Concrete Cloth, Rock Pad, and Woven Microgrid Geotextile



Concrete Cloth

Roll—3.375' x 30'

#85026 MSRP \$1,050.99

Packaged Weight: 141 lb

- Flexible cement impregnated fabric that hardens after hydration
- Acts as a protective barrier between liner and large rocks
- Protects liner from digging animals, vandalism, and more

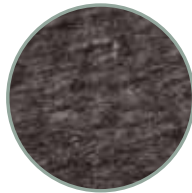

Rock Pad

3' x 3'

#25000 MSRP \$36.99

Packaged Weight: 1.1 lb

The rock pad is an extra thick 3' x 3' non-woven polypropylene fabric that can be laid down on the liner before placing large rocks.

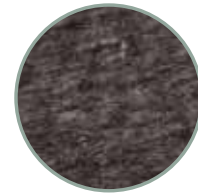

Rock Pad

Roll—15' x 150'

#25001 MSRP \$2,359.99

Packaged Weight: 260 lb

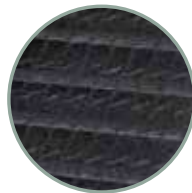

Woven Microgrid Geotextile

8' x 225'

#42016 MSRP \$1,349.99

Packaged Weight: 65 lb

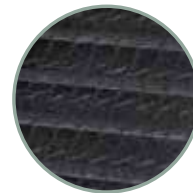

Woven Microgrid Geotextile

4' x 4'

#42015 MSRP \$19.99

Packaged Weight: .5 lb



PIPE AND PLUMBING

Flexible PVC Pipe makes installations quick and easy. The main advantage of this high-quality pipe is that it has the durability to be glued into standard schedule 40 PVC fittings.

- Simplifies plumbing layouts and installations
- Sun, ozone, and mildew resistant—NOTE: we do not recommend placing flexible PVC pipe in continuous sunlight
- Made in the USA

Kink-Free Pipe is an excellent choice for quick and easy installations without the use of PVC cement. This high quality pipe is extremely flexible and resistant to crimping or collapsing around tight curves. Kink-Free Pipe works best when used with traditional stainless steel hose clamps and barbed fittings.

- Simplifies plumbing layouts and installations
- Internal spiral prevents crushing and smooth inner wall reduces friction and maximizes flow
- Made in the USA

Pre-cut Kink-Free Pipe is ideal for fountain installations. The pieces are cut and packaged in convenient six-foot sections, ideal for installations requiring smaller lengths of pipe.

- Internal spiral prevents crushing and smooth inner wall reduces friction and maximizes flow
- Works best when used with traditional barbed fittings and stainless steel hose clamps
- Made in the USA

Black Vinyl Tubing is ideal for recirculating water in fountains and other water features without the use of PVC glue. Our non-toxic, vinyl tubing is fish-safe, allowing for use in water features containing fish and plants.

- Durable construction
- Prevents kinking
- Flexibility makes installation quick and easy

Plumbing Materials provided by Aquascape include a complete selection of check valves, automatic water fill valves, and a variety of accessories, making it easy to complete any water feature with high quality plumbing products.

- Simplifies maintenance and installation
- Durable, professional quality products
- Easy to adapt to a variety of pipe types and sizes

Pipe and Plumbing



Flexible PVC Pipe

Item #	MSRP	Pipe Dimensions	Packaged Weight
#48015	\$107.99	1" x 50'	14.5 lb
#29021	\$80.99	1½" x 25'	13 lb
#29022	\$147.99	1½" x 50'	24 lb
#29023	\$107.99	2" x 25'	14 lb
#29024	\$200.99	2" x 50'	30.75 lb
#29025	\$455.99	3" x 25'	57 lb
#29026	\$803.99	3" x 100'	118 lb



Kink-Free Pipe

Item #	MSRP	Pipe Dimensions	Packaged Weight
#98288	\$162.98	½" x 100'	9.25 lb
#94002	\$54.98	¾" x 25'	3.5 lb
#94003	\$207.98	¾" x 100'	17.75 lb
#94001	\$64.98	1" x 25'	4 lb
#94004	\$235.98	1" x 100'	16.75 lb
#94000	\$70.98	1¼" x 25'	6 lb
#94005	\$281.98	1¼" x 100'	23 lb
#94006	\$95.98	1½" x 25'	5.75 lb
#94007	\$308.98	1½" x 100'	38.5 lb



Pre-Cut Kink-Free Pipe

Item #	MSRP	Pipe Dimensions	Packaged Dimensions	Packaged Weight
#88003	\$20.98	½" x 6'	10"L x 12"W x ¾"H	5 lb
#98404	\$21.98	¾" x 6'	14"L x 13"W x 1"H	1 lb

Pipe and Plumbing (Continued)



Black Vinyl Tubing			
Item #	MSRP	Pipe Dimensions	Packaged Weight
#94008	\$125.98	3/8" x 100'	7 lb
#94010	\$140.98	3/4" x 50'	11.75 lb
#94009	\$207.98	1/2" x 100'	6 lb
#94011	\$251.98	1" x 50'	12.25 lb

Check Valves and Flow Control Valves



Dual Union Check Valve 2.0

#48026 MSRP \$82.99

Packaged Weight: 3.75 lb

The Dual Union Check Valve 2.0 provides a professional pump and plumbing connection inside skimmer filter systems, as well as Pondless® Waterfall Vaults. The innovative reversible fittings allow for universal application. The Dual Union Check Valve 2.0 prevents water backflow when the pump is not operating, while the dual-union, tool-free design makes maintenance quick and easy. The height is extendable for larger filters and pumps.



Features and Benefits

- ① Angled, swing-style valve effectively prevents back flow
- ② Heavy-duty flapper ensures longevity
- ③ Dual-union connections simplify pump and filter maintenance

Reversible
Fittings
Eliminate
Guesswork



FITTINGS INCLUDED

- (2) Reversible 2" MPT x 2" Slip,
(1) Reversible 1.5" FPT x 2" Slip



Dual Union 3" CVA Check Valve

#29098 MSRP \$169.99

Packaged Weight: 7.5 lb

The Dual Union 3" CVA Check Valve is ideal for larger installations that use large pumps and filters. Heavy-duty, dual-union design ensures years of trouble-free use.



2-Way Flow Control Valve

#88005 MSRP \$53.98

Packaged Weight: 1.5 lb

Water Fill Valves

Aquascape Water Fill Valves automatically add water to features when needed. They reduce the time-consuming maintenance of manually filling water features with a hose. Water Fill Valves also help protect the pump from running dry and eliminate large water chemistry swings (including chlorine/chloramine levels) that occur during manual top-offs.



Compact Water Fill Valve

#88006 MSRP \$44.99

Packaged Weight: .75 lb

- Up to 1.5 gallons per minute flow rate at a working pressure of 0-100 PSI
- Small size allows it to fit into any skimmer filter, Pondless® Waterfall Vault, or decorative water feature application
- Includes fittings to connect to a standard garden hose, 1/4" poly-pipe, 1/2" poly-pipe, 1/2" pvc pipe (pipe sold separately)



Water Fill Valve 200

#29272 MSRP \$73.98

Packaged Weight: 1 lb

- Up to 3 gallons per minute flow rate at a working pressure of 0-100 PSI
- Reliable mechanical arm-style fill valve
- Brass hardware with poly float
- Includes fittings to connect to 1/2" poly-pipe or 1/2" pvc pipe (pipe sold separately)



Hudson Water Fill Valve

#29469 MSRP \$107.99

Packaged Weight: 1.25 lb

- Up to 1.5 gallons per minute flow rate at working pressure of 8-65 PSI
- Works great in Signature Series Pond Skimmers and Pondless® Waterfall Vault
- Mounting plate allows 4-inch setting adjustments
- Includes quick-connect fitting for 1/4" poly pipe
- Can also be used with 1/2" PVC by using the Fill Valve Irrigation Conversion Kit (Item #01008)

Water Fill Valve Accessories



Fill Valve Spigot 1/4" Quick-Connect

#07000 MSRP \$26.99

Packaged Weight: 0.25 lb

Connects 1/4" poly pipe to garden spigot.



Garden Hose Adapter Assembly

#29517 MSRP \$12.99

Packaged Weight: 0.25 lb

Connects 1/2" poly pipe to garden spigot.



Fill Valve Irrigation Conversion Kit

#01008 MSRP \$10.99

Packaged Weight: 0.05 lb

Converts the 1/4" Hudson Water Fill Valve up to 1/2" poly pipe or PVC.



WFV Poly Pipe Roll 1/4" x 100'

#29350 MSRP \$29.98

Packaged Weight: 1.25 lb



WFV Poly Pipe Roll 1/2" x 100'

#29470 MSRP \$73.98

Packaged Weight: 5 lb



INSTALLATION TOOLS

Whether you are a do-it-yourselfer or professional water feature contractor, Aquascape has all the pieces and parts you need for successful installation or repair. Installation tools, spare parts, and accessories are available individually or as part of a kit. Installation tools located within this section of the catalog include the following.

- Foam
- Foam Guns
- Patches
- Silicone
- Glue

Installation Tools



Economy Foam Gun Applicator

#54003 MSRP \$66.99

Packaged Weight: 1.5 lb

This lower-priced foam gun provides an attractive price point so that all contractors, no matter how many features they build, can afford to add a foam gun to their pond-building tool kit. To be used with Professional Black Waterfall Foam.



Professional Foam Gun Applicator

#29268 MSRP \$296.99

Packaged Weight: 1.25 lb

Aquascape Professional Foam Gun Applicator is designed to create an air and moisture-tight seal between the gun and the can, allowing for maximum foam yield and minimal waste. To be used with Professional Black Waterfall Foam.



Professional Foam Gun Kit

#22013 MSRP \$495.99

Packaged Weight: 13.5 lb

Kit includes:

- Case
- Professional Black Waterfall Foam (3)
- Professional Foam Gun Applicator
- Professional Foam Gun Cleaner



Professional Black Waterfall Foam

#30096 MSRP \$40.99

Packaged Weight: 2 lb

24 oz. can of expandable Professional Black Waterfall Foam. Equivalent to Pond and Waterfall Foam Sealant. To be used with foam guns (sold separately).



Professional Foam Gun Cleaner

#22011 MSRP \$40.99

Packaged Weight: 1.25 lb

A handy cleaner to flush the foam gun clean if it is not working properly. It will also remove uncured foam.



Pond and Waterfall Foam Sealant

#21053 MSRP \$26.98

Packaged Weight: 1.25 lb

No gun applicator needed! Easy to use for the beginner or do-it-yourselfer. Convenient and economical for a small project or the quick touch-up on a larger project. Also sold as part of our Installation Kit (#22008).



Black Silicone Sealant

4.7 oz

#22010 MSRP \$9.98

Packaged Weight: .5 lb

- Used for sealing joints where liner attaches to BioFalls® lip and the skimmer faceplate
- Fish-safe



Black Silicone Sealant

10.1 oz

#29186 MSRP \$16.99

Packaged Weight: .5 lb

- Used for sealing joints where liner attaches to BioFalls® lip and the skimmer faceplate
- Fish Safe



Clear Silicone Sealant

10.1 oz

#82000 MSRP \$16.99

Packaged Weight: .75 lb

- Used for sealing joints where liner attaches to BioFalls® lip and the skimmer faceplate
- Fish Safe

Installation Tools (Continued)



Installation Kit

#22008 MSRP \$46.99

Packaged Weight: 2.25 lb

Kit includes:

- Liner Patch
- Christy's Red Hot Blue Glue
- Black Silicone Sealant
- Pond and Waterfall Foam Sealant



Cleanout Pump

#45033 MSRP \$669.99

Packaged Weight: 26.5 lb

- Great for pond cleanouts and installation wash-downs
- 4,200 GPH for fast pump-outs
- Pumps water down to 1/4" off the bottom



Cleanout Pump Discharge Hose 50'

#48019 MSRP \$134.99

Packaged Weight: 14.75 lb

- Heavy-duty cleanout discharge hose engineered for flexibility and optimal flow
- Swivel cuff fitting prevents kinking or tangling, allowing easy movement around the water feature



Firestone® QuickSeam Pond Liner Repair Kit

#42023 MSRP \$46.99

Packaged Weight: .5 lb

Kit includes:

- 6" x 6" QuickSeam patches
- Bottle of LVOC Primer (2 oz/57 ml)
- Scrubber pad
- Patch roller
- Pair of disposable gloves



Firestone® QuickScrubber Kit

#54009 MSRP \$53.99

Packaged Weight: .75 lb

Kit consists of 30 scrub pads and 4 holders designed for the application of Firestone® QuickPrime Plus—EPDM Liner Seaming Tape Primer.



Firestone® QuickPrime Plus—EPDM Liner Seaming Tape Primer

1 qt. / 0.95 L

#54008 MSRP \$66.99

Packaged Weight: 2 lb

QuickPrime Plus is designed to clean and prime EPDM liner prior to seaming.



EPDM Liner Patch 6"

#22018 MSRP \$13.98

Packaged Weight: 0.25 lb

This 6" self-adhesive patch quickly repairs holes, tears, and cuts in liner.



EPDM Liner One-Sided Cover Tape

6" x 25'

#22003 MSRP \$174.99

Packaged Weight: 6.25 lb



EPDM Liner One-Sided Cover Tape

6" x 100'

#22005 MSRP \$334.99

Packaged Weight: 20 lb



Christy's Red Hot Blue Glue

4 oz

#29969 MSRP \$13.99

Packaged Weight: 0.4 lb

The original all-weather, wet or dry PVC cement.



EPDM Liner Double-Sided Seam Tape

3" x 25'

#22017 MSRP \$71.99

Packaged Weight: 2 lb



EPDM Liner Double-Sided Seam Tape

3" x 100'

#22020 MSRP \$174.99

Packaged Weight: 20 lb



RAINWATER HARVESTING

Why Harvest Rainwater?

The Aquascape Rainwater Harvesting System (formerly known as RainXchange®) is a sustainable solution for water conservation and stormwater management.

Water Conservation

- According to the World Wildlife Fund, 1.1 billion people worldwide lack access to water and by 2025, two-thirds of the world's population may face water shortages.*
- Capturing and reusing rainwater reduces the community's demand on the municipal water supply, reduces the owner's water bills, and helps avoid strict water schedules.

Stormwater Management

- According to the EPA, stormwater run-off is one of the main reasons that our lakes, rivers, and estuaries are not clean enough for fishing or swimming.**
- Rainwater harvesting is a solution for managing stormwater run-off and decreasing flooding.
- Federal, state, and local regulations are requiring stormwater to be managed at the source. The Aquascape Rainwater Harvesting System provides a solution to help meet these governmental regulations.

*"Water Scarcity." WorldWildlife.org. World Wildlife Fund, n.d. Web. 10 Nov. 2016.

**National Research Council. "Urban Stormwater Management in the United States." The National Academies Press. Web. 15 Oct. 2008.

Aquascape Rainwater Harvesting System Components —Pondless® Waterfall—

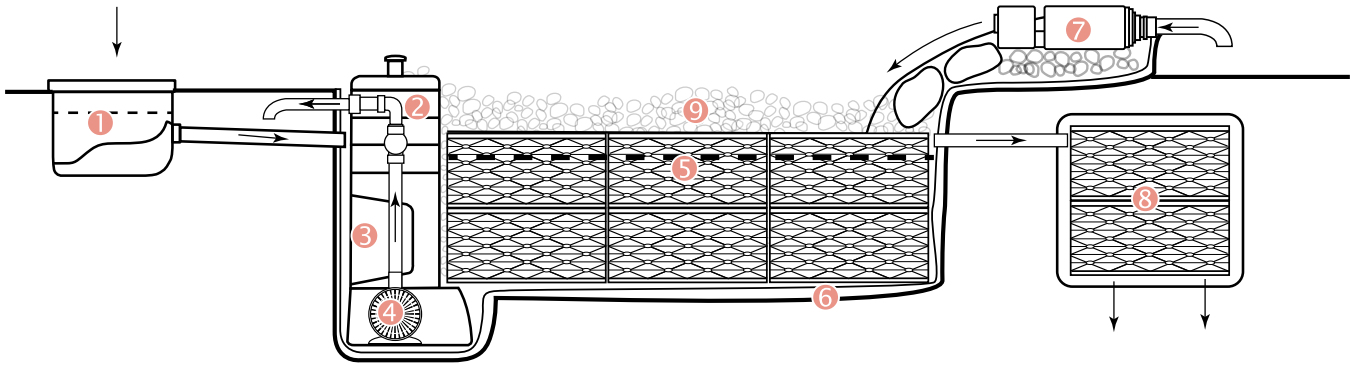

① Downspout Filter

② Pondless® Waterfall Vault Extensions

③ Pondless® Waterfall Vault

④ Pump

⑤ AquaBlox® Water Storage Modules

⑥ Liner and Underlayment

⑦ Waterfall Spillway

⑧ Overflow Drainage

⑨ Rocks and Gravel

Aquascape Rainwater Harvesting System Components —Fountain—

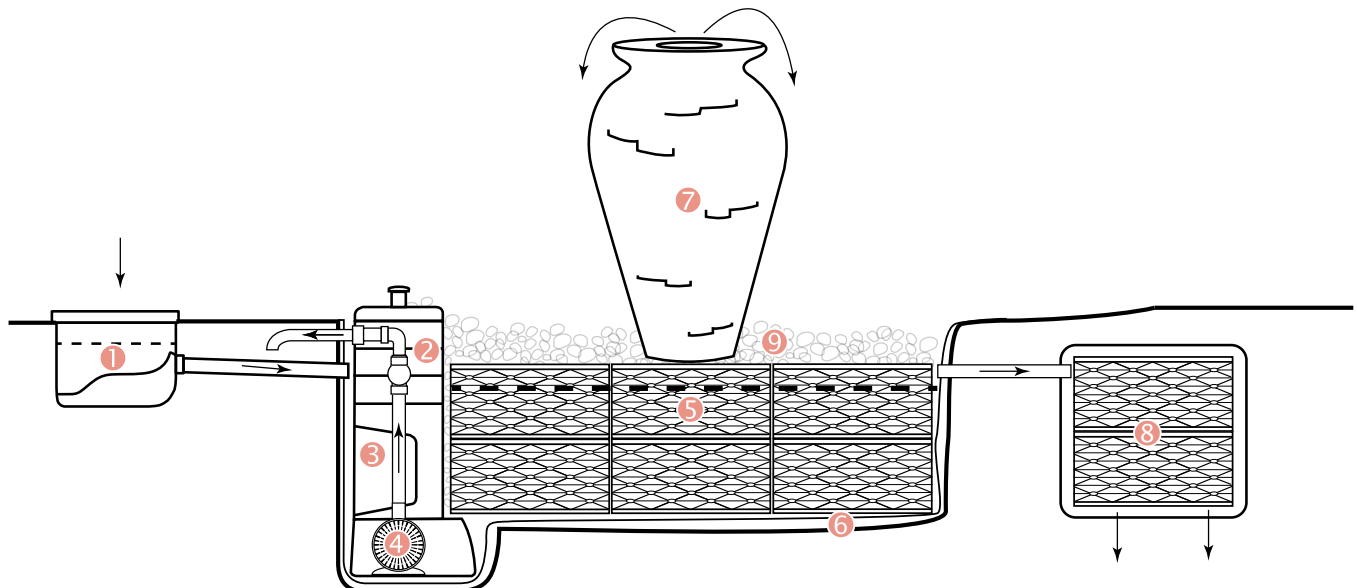

① Downspout Filter

② Pondless® Waterfall Vault Extensions

③ Pondless® Waterfall Vault

④ Pump

⑤ AquaBlox® Water Storage Modules

⑥ Liner and Underlayment

⑦ Decorative Fountain

⑧ Overflow Drainage

⑨ Rocks and Gravel

Step 1: Choose The Water Storage System

Each Aquascape Rainwater Harvesting System Water Storage Kit Includes: Pondless® Waterfall Vault Extension(s), AquaBlox®, 45 mil EPDM Liner, and two pieces of non-woven geotextile underlayment (one to surround the AquaBlox and one to surround the exterior of the EPDM liner).



500 Gallon Water Storage Kit

#30097 MSRP \$1,799.99

- Basin Size: 6' x 9' x 4'
- (16) AquaBlox® Large Water Storage Modules
- 45 mil EDPM Liner—15' x 20'
- (2) Underlayment—300 sq. ft.
- Pondless® Waterfall Vault Extension

1000 Gallon Water Storage Kit

#30099 MSRP \$3,349.99

- Basin Size: 6' x 9' x 5'
- (32) AquaBlox® Large Water Storage Modules
- 45 mil EDPM Liner—20' x 25'
- (2) Underlayment—500 sq. ft.
- (4) Pondless® Waterfall Vault Extensions

1500 Gallon Water Storage Kit

#30102 MSRP \$4,799.99

- Basin Size: 8' x 9' x 5'
- (48) AquaBlox® Large Water Storage Modules
- 45 mil EDPM Liner—25' x 25'
- (2) Underlayment—625 sq. ft.
- (4) Pondless® Waterfall Vault Extensions

2000 Gallon Water Storage Kit

#30105 MSRP \$5,999.99

- Basin Size: 9' x 11' x 5'
- (64) AquaBlox® Large Water Storage Modules
- 45 mil EDPM Liner—25' x 30'
- (2) Underlayment—750 sq. ft.
- (4) Pondless® Waterfall Vault Extensions

2500 Gallon Water Storage Kit

#30108 MSRP \$6,999.99

- Basin Size: 11' x 12' x 5'
- (80) AquaBlox® Large Water Storage Modules
- 45 mil EDPM Liner—25' x 30'
- (2) Underlayment—750 sq. ft.
- (4) Pondless® Waterfall Vault Extensions

3000 Gallon Water Storage Kit

#30112 MSRP \$7,999.99

- Basin Size: 9' x 11' x 6'
- (96) AquaBlox® Large Water Storage Modules
- 45 mil EDPM Liner—25' x 30'
- (2) Underlayment—750 sq. ft.
- (6) Pondless® Waterfall Vault Extensions

Step 2: Choose The Water Feature



Rainwater Harvesting Fountain Add-On Kit

#44000 MSRP \$1,599.99

Select from a number of decorative bubbling urns and stone fountains (seen on pages 90-108) that sit on top of the Aquascape Rainwater Harvesting System. The water spills over the top of the decorative piece and flows back down into the Aquascape Rainwater Harvesting Water Storage System where it is re-circulated.

Kit Includes:

- Pondless® Waterfall Vault
- Downspout Filter
- AquaSurge® 2000-4000 Adjustable Flow Pond Pump
- Kink-Free Pipe—¾" x 25'
- Overflow Kit
- Decorative Fountain Component Bag



Rainwater Harvesting Pondless® Waterfall Add-On Kit

#44001 MSRP \$2,399.99

This water feature is made up of a waterfall or stream that flows and then disappears gracefully into the gravel.

Kit Includes:

- Pondless® Waterfall Vault
- Waterfall Spillway
- Downspout Filter
- AquaSurge® 2000-4000 Adjustable Flow Pond Pump
- LED Lighting Package
- Flexible PVC Pipe—2" x 25'
- 45 mil EPDM Liner—10' x 20'
- Overflow Kit
- Installation Kit



Rainwater Harvesting Downspout Filter

#30166 MSRP \$308.99

The Downspout Filter is installed at the base of the downspout ready to capture and remove a variety of debris that may be flushed into the system during a rain event. Incoming rainwater is passed through a series of mechanical filters that remove leaves, twigs, seeds, and small sediment that accumulate on the surface of the roof between rain events.

- Utilize our online Rainwater Harvesting Calculator to determine how many Downspout Filters your project will require.
- Add a downspout filter onto a water feature and use rainwater to top off the water level.
- Handles up to a 1,500 sq. ft. roof and more than 50 gallons per minute flow rate.
- Add a downspout filter to any water feature and make it sustainable!

Step 3: Choose The Decorative Fountain



Small Stacked Slate Sphere

#78287 MSRP \$499.98
See page 111 for more information.



Medium Scalloped Urn

#78239 MSRP \$849.98
See page 114 for more information.



Natural Mongolian Basalt Columns Set of 3

#58062 MSRP \$1,339.98
See page 117 for more information.

Small Stacked Slate Urn

#98939 MSRP \$499.98
See page 114 for more information.

Medium Rippled Urn

#78242 MSRP \$849.98
See page 115 for more information.

Pagoda Fountain Rocks Set of 3

#78219 MSRP \$1,209.98
See page 116 for more information.

For more fountain options, see pages 111—117

Index

Symbols

- 2-Outlet Pond Aeration Kit 57
 - 2-Watt LED Color-Changing Waterfall and Up Light 70
 - 2-Way Aeration Compressor Manifold 59
 - 2-Way Flow Control Valve 125
 - 3-Way Color-Changing Splitter 72
 - 4.5-Watt LED Color-Changing Spotlight 70
 - 4-Outlet Pond Aeration Kit 57
 - 6-Way Color-Changing Splitter 72
 - 8-Watt LED Color-Changing Spotlight 70
 - 10" Rubber Membrane Aeration Diffuser 59
 - 25' 5-Outlet Color-Changing Lighting Extension Cable 72
 - 25' Color-Changing Lighting Extension Cable 72
 - 45 mil EPDM Liner Rolls 121
 - 70 GPH Water Pump 54
 - 90 GPH Water Pump 54
 - 180 GPH Water Pump 54
 - 300-Watt Pond De-Icer 96
 - 320 GPH Water Pump 54
- A**
- Activated Pond Carbon 84
 - Adjustable Flow Pond Pumps 7, 40, 42, 43, 48
 - Adjustable Flow Solids-Handling Pond Pumps 48
 - Adjustable Pouring Bamboo Fountain 107
 - Aeration 56
 - Algaecide 86
 - Alkalinity Booster 84
 - Alligator Spitter 108
 - Ammonia Neutralizer 84
 - Ammonia Neutralizer Professional Grade 90
 - AquaBasin® 30 110
 - AquaBasin® 45 110
 - AquaBasin® Medium 110
 - AquaBlox® Water Storage Module 34
 - AquaForce® Adjustable Flow Solids-Handling Pond Pump 48
 - AquaForce® Solids-Handling Pond Pumps 48, 49
 - AquaGarden Mini Pond Kit 7, 106
 - AquaJet® Pond Pump 50
 - Aquamarine Fire Glass 105
 - AquaRock Fountain Kits 119
 - AquascapePRO Pond Pumps 45
 - AquaSurge® Adjustable Flow Pond Pumps 40, 41, 48
 - AquaSurge® Pond Pumps 40
 - Aquatic Patio Pond Kit 106
 - Aquatic Plant Care 102
 - Aquatic Planters 103
 - Automatic Dosing System 77
 - Automatic Dosing System for Fountains 77
 - Automatic Dosing System for Ponds 77
- B**
- Backyard Waterfall Landscape Fountain Kit 12, 15, 17, 118
 - Bacteria Bubble Tabs 82
 - Barbed Coupling 3/8" 59
 - Barley Straw Extract 85
 - Barley Straw Extract Professional Grade 90
 - Beneficial Bacteria 81
 - Beneficial Bacteria Concentrate 81, 83, 85
 - Beneficial Bacteria Concentrate Professional Grade 89
 - Beneficial Bacteria Professional Grade 89
 - Beneficial Bacterias 81, 82
 - BioBalls Biological Filter Media 1,000 Count 28
 - BioBalls Biological Filter Media 100 Count 28
 - BioBalls Filter Media Net 28
 - BioFalls® Filters 24, 25
 - Black Pond Dye 86
 - Black Silicone Sealant 128
 - Black Vinyl Tubing 123, 125
 - Blue Heron Decoy 93
 - Blue Pond Tint 86
 - Bulk Protective Pond Netting 95
- C**
- Christy's Red Hot Blue Glue 129
 - Clean for Fountains 80
 - Clean for Ponds 79
 - Cleanout Pump 55, 129
 - Cleanout Pump Discharge Hose 50' 55, 129
 - Clear for Ponds 78
 - Clear Silicone Sealant 128
 - Coarse Filter Media Roll 1.25" Thick 28
 - Coarse Filter Media Roll 2" Thick 28
 - Cold Water Beneficial Bacteria 81, 82, 96
 - Cold Water Beneficial Bacteria Professional Grade 89
 - Collapsible Pond and Fish Net 100
 - Collapsible Pond Skimmer Net 100
 - Color-Changing Lighting Control Hub 69
 - Color-Changing Lighting Remote 69
 - Compact Water Fill Valve 126
 - Concentrated Barley Straw Pellets 86
 - Concrete Cloth 122
 - Container Water Garden Filter 27
 - Contractor Grade Water Treatments 89, 90
 - Crane with Lowered Head Spitter 108
 - Crazy Legs Frog Spitter 108
 - CU/Copper Test Kit 37
 - Curved Stacked Slate Wall 112
- D**
- DecoBasin 110
 - Decorative 104
 - Decorative River Pebbles—Black 109
 - Decorative River Pebbles—Mixed 109
 - Deer Scarer Bamboo Fountain 107
 - Deluxe Pond Kits 7, 12
 - Deluxe Pondless® Waterfall Kits 7, 17
 - Dense Filter Media Roll 1" Thick 28
 - DIY Backyard Pond Kit 4' x 6' 10
 - DIY Backyard Pond Kit 6' x 8' 10
 - DIY Backyard Pond Kit 8' x 11' 10
 - DIY Backyard Waterfall Kit 15
 - Double Frog with Cattail Spitter 108
 - Double-Textured Basalt Columns Set of 3 117
 - Dragonfly Spitter 108
 - Dual Union 3" CVA Check Valve 125
 - Dual Union Check Valve 2.0 125
- E**
- Economy Foam Gun Applicator 128
 - EcoWave Pond Pumps 46, 47
 - EPDM Liner Double-Sided Seam Tape 129
 - EPDM Liner One-Sided Cover Tape 129
 - EPDM Liner Patch 6" 129
 - Extension Cables 66
- F**
- Faux Driftwood 30" 109
 - Faux Driftwood 35" 109
 - Faux Log Fish Cave 7, 93, 109
 - Faux Oak Stump Cover 109
 - Fill Valve Irrigation Conversion Kit 126
 - Fill Valve Spigot 1/4" Quick-Connect 126
 - Filtration 21
 - Fire Fountain 24" 105
 - Fire Fountain 28" 105
 - Fire Fountain 32" 105
 - Fire Fountain Add-On Kit for Rippled Urns 105, 115
 - Fire Fountain Add-On Kit for Scalloped Urns 105, 115
 - Fire Fountain Add-On Kit for Stacked Slate Fountains 105, 114
 - Fire Fountain Add-On Kit for Stacked Slate Fountains 111
 - Fire Fountain Add-On Kit for Stacked Slate Urns 105, 111, 114
 - Fire Fountain Add-On Kits 105
 - Fire Fountains 105
 - Fire Glass 105
 - Firestone® QuickPrime Plus—EPDM Liner Seaming Tape Primer 129
 - Firestone® QuickScrubber Kit 129
 - Firestone® QuickSeam Pond Liner Repair Kit 129
 - Fish Care 97
 - Fish Food 98, 99
 - Fish Treatments 101
 - Flexible PVC Pipe 118, 123, 124, 133
 - Floating Alligator Decoy 93
 - Floating Plant Island 103
 - Fountain Foam Free 88
 - Fountain Maintenance 88
 - Fountain Scale Free 88
 - Fountain Shims 109
 - Fountain Treatments 88
 - Frog on Reed Spitter 108
- G**
- Garden and Pond 1-Watt LED Spotlight 62
 - Garden and Pond 1-Watt LED Spotlight 6-Pack 67
 - Garden and Pond 1-Watt LED Waterfall and Up Light 62
 - Garden and Pond 1-Watt LED Waterfall and Up Light 6-Pack 67
 - Garden and Pond 3-Watt LED Spotlight 62
 - Garden and Pond 3-Watt LED Spotlight 6-Pack 67
 - Garden and Pond 3-Way Quick-Connect Splitter 66
 - Garden and Pond 6-Watt 12V Quick-Connect Transformer 74
 - Garden and Pond 6-Watt LED Spotlight 62
 - Garden and Pond 6-Watt LED Spotlight 6-Pack 67
 - Garden and Pond 6-Way Quick-Connect Splitter 66
 - Garden and Pond 20-Watt 12V Quick-Connect Transformer 74
 - Garden and Pond 25' 5-Outlet Quick-Connect Lighting Extension Cable 66
 - Garden and Pond 25' Quick-Connect Lighting Extension Cable 66
 - Garden and Pond 60-Watt 12V Quick-Connect Transformer 74
 - Garden and Pond 60-Watt Transformer with Photocell 74
 - Garden and Pond 150-Watt Transformer with Photocell 74
 - Garden and Pond LED Lights 62, 63
 - Garden and Pond LED Spotlight Kit 61
 - Garden and Pond Photocell with Digital Timer 66, 74
 - Garden Hose Adapter Assembly 126
- H**
- Heavy Duty Pond Net with Extendable Handle 100
 - Heavy Duty Pond Skimmer Net with Extendable Handle 100
 - High Density Rigid Filter Mat 28
 - Hudson Water Fill Valve 126
- I**
- Installation Kit 129
 - IonGen™ G2 Probe Holder 37
 - IonGen™ Probe for the G1.5 System 37
 - IonGen™ Probe for the G2 System 37
 - IonGen™ System G2 36
- K**
- Keyed Basalt Columns Set of 3 117
 - KH/Alkalinity Test Kit 37
 - Kid's Pond Explorer Net 100
 - Kink-Free Pipe 31, 117, 123, 124, 133
 - Koi Krunchies 98
- L**
- Lake Bacteria 91
 - Lake Bacteria Packs 91
 - Lake Blue Dye Packs 92
 - Lake Flocculant Clarifier 91
 - Lake Phosphate Binder Packs 92
 - Lake Sludge Remover Packs 91
 - Lake Treatment Booster Packs 92
 - Lake Treatments 91, 92
 - Landscape Fountain Kits 18
 - Large Centipede® Module 35
 - Large Deluxe Pond Kit 21' x 26' 12

Index (Continued)

- Large Deluxe Pondless® Waterfall Kit 26' Stream 17
Large Pond Kit 21' x 26' with AquaSurge® 4000–8000 Pond Pump 11
Large Pondless® Waterfall Kit 26' Stream with AquaSurge® 4000–8000 Pond Pump 16
Large Snorkel® Vault and Cap 35
Lazy Frog on Lily Pad Spitter 108
LED Color-Changing Fountain Light 71
LED Color-Changing Fountain Light with Transformer 71
LED Color-Changing Lights 70
LED Fountain Accent Light 64
LED Fountain Accent Lights 64
LED Fountain Accent Light with Transformer 64
LED Lighting 6-Packs 67
Lighting 60
Liner, Underlayment, and Geotextile 120
Low Density Rigid Filter Mat 28
- M**
Maintain for Ponds 78
Maintenance Tabs 88
Man in Barrel Spitter 108
Medium Deluxe Pond Kit 11' x 16' 12
Medium Deluxe Pondless® Waterfall Kit 16' Stream 17
Medium Density Rigid Filter Mat 28
Medium Pond Kit 11' x 16' with AquaSurge® 2000–4000 Pond Pump 11
Medium Pondless® Waterfall Kit 16' Stream with AquaSurge® 2000–4000 Pond Pump 16
Medium Rippled Urn Landscape Fountain Kit 20, 115
Medium Scalloped Urn Landscape Fountain Kit 20, 115
Medium Stacked Slate Sphere Landscape Fountain Kit 20, 111
Medium Stacked Slate Urn Landscape Fountain Kit 20, 114
Mongolian Basalt Column 30" Landscape Fountain Kit 20, 117
Mongolian Basalt Columns Set of 3 Landscape Fountain Kit 20, 117
- N**
Natural Mongolian Basalt Column 24" 117
Natural Mongolian Basalt Column 30" 117
Natural Mongolian Basalt Column 36" 117
Natural Mongolian Basalt Columns Set of 3 117
Naughty Dog Spitter 108
Nets 100
- P**
Pagoda Fountain Rocks Set of 3 116
Pagoda Fountain Rocks Set of 3 Landscape Fountain Kit 20, 116
Path and Area 3-Watt LED Dome Top Landscape Light 67
Path and Area 3-Watt LED Hat Top Landscape Light 65
Path and Area 3-Watt LED Hat Top Landscape Light 6-Pack 67
Path and Area LED Landscape Lights 65
Patio Pond Maintenance Tabs 88
Patio Ponds 107
Photocell 66
Pipe and Plumbing 123
PL Solids-Handling Pond Pumps 44
PN Solids-Handling Pond Pumps 44
Pond Aeration Kits 57, 96
Pond Aerator Aeration Disc 57
Pond and Waterfall Foam Sealant 128
Pond & Debris Clarifier Professional Grade 89
Pond Detoxifier Professional Grade 90
Pond Detoxifier 84
Pond Filter Urn 26
Pond Foam Free 84
Pond Kits 8
Pondless® Waterfall Kits 13
Pondless® Waterfall Vault 33
Pondless® Waterfall Vault Extension 33
Pond Net with Extendable Handle 100
Pond Plant Potting Media 103
Pond Powerhead 51, 96
Pond Salt 101
Pond Shark 100
Pond Shark Pro 100
Pond Skimmer Filters 22, 23
Pond Skimmer Net with Extendable Handle 100
Pond Sludge Remover Packs 83, 84
Pond Starter Bacteria 82
Pond Starter Bacteria Professional Grade 89
Pond Waterfall Filter 26
Pouring 3-Tier Bamboo Fountain 107
Pre-Cut Kink-Free Pipe 124
Predator Control 93
Premium Cold Water Fish Food Pellets 96, 99
Premium Color Enhancing Fish Food Pellets 99
Premium Fish Food Flakes 98
Premium Staple Fish Food Pellets 98
Prevent for Fountains 80
Pro Air 20 Aeration Compressor 59
Pro Air 20 Pond Aeration Kit 58
Pro Air 60 Aeration Compressor 58, 59
Pro Air 60 Pond Aeration Kit 58
Pro Air Pond Aeration Kits 58
Problem Solving 85, 86, 87
Professional Black Waterfall Foam 128
Professional Fish Net with Extendable Handle 100
Professional Foam Gun Applicator 128
Professional Foam Gun Cleaner 128
Professional Foam Gun Kit 128
Professional Grade Pond Net 100
Professional Grade Pond Skimmer Net 100
Protect for Ponds 79
Protective Pond Netting 95
Pump Cleaner Maintenance Solution 55
Pumps 38
- R**
Rainwater Harvesting Fountain Add-On Kit 133
Rainwater Harvesting Pondless® Waterfall Add-On Kit 133
Rainwater Harvesting System Water Storage Kits 132
Rapid Clear Fine Filter Pads 85
Rapid Clear Flocculant 85
Rapid Clear Flocculant Professional Grade 89
Reflective Black Fire Glass 105
Reflective Cobalt Blue Fire Glass 105
Rippled Urn 115
Rock and Fountain Cleaner 88
Rock Pad 122
Rock Pad Roll 122
- S**
SAB Stream & Pond Cleaner 85
SAB Stream & Pond Cleaner Professional Grade 90
Scalloped Urn 114
Seasonal Care 94
Semi-Polished Stone Basalt Columns Set of 3 117
Signature Series 200 Pond Skimmer 22
Signature Series 400 Pond Skimmer 22
Signature Series 1000 BioFalls® Filter 24
Signature Series 1000 Pond Skimmer 22
Signature Series 2500 BioFalls® Filter 24
Signature Series 6000 BioFalls® Filter with 2" Bulkhead 24
Signature Series 6000 BioFalls® Filter with 3" Bulkhead 24
Simple Solutions Water Treatments for Fountains 80
Simple Solutions Water Treatments for Ponds 78, 79
SLD Adjustable Flow Pond Pumps 7, 42, 43
Sludge Cleaner Bubble Tabs 83
Sludge Fighting 83
Sludge & Filter Cleaner 83
Sludge & Filter Cleaner Professional Grade 90
Small Pond Kit 8' x 11' 11
Small Pondless® Waterfall Kit 6' Stream 16
Small Stacked Slate Urn Fountain Kit 114
Smart Control Conversion Plug 7, 39, 40, 48
Smart Control Hub for color-changing lights 6, 68, 69, 70, 71
Smart Control Plug 6, 73, 74
Smart Control Receiver 6, 7, 39, 40, 42, 43, 48
Snorkel® Vault Extension 35
Spillway Basin 40" 116
Spillway Bowl 32" 116
Spillway Bowl and Basin Landscape Fountain Kit 20, 116
Spillway Bowl Stand 116
Splitters 66
Stacked Slate Spheres 111
Stacked Slate Spillway Wall 32" Landscape Fountain Kit 20, 113
Stacked Slate Topper 112
Stacked Slate Urn 114
Stacked Slate Walls 112, 113
Stainless Steel WaterWall Spillway 119
Stainless Steel WaterWall Spillway Kit 119
Standing Crane Spitter 108
Statuary Water Pumps 54
Stone Basalt Columns 117
Straight Stacked Slate Topper 113
Straight Stacked Slate Wall Base 113
Submersible Pond Filter 27
Submersible Pond Thermometer 96
- T**
Textured Gray Slate Patio Pond 107
Toucan Spitter 108
- U**
UltraKlean™ 1500 Pond Filtration Kit 31
UltraKlean™ 2000 Pond Filter 30
UltraKlean™ 2500 Pond Filtration Kit 31
UltraKlean™ 3500 Pond Filter 30
UltraKlean™ 3500 Pond Filtration Kit 31
UltraKlean™ Pond Filters 30
UltraKlean™ Pond Filtration Kits 31
UltraKlean® UV Clarifier 29
Ultra Water Pump Fountain Head Kits 52
Ultra Water Pumps 52
U-Shaped Ground Stakes 95
- W**
Water Conditioners 84
Waterfall & Rock Cleaner Professional Grade 90
Waterfall Spillway 32
Waterfall Spillway 12" 7, 32
Water Fill Valve 200 126
Water Fill Valves 126
Water Treatments 75
Weighted Aeration Tubing 59
Wetland Pond & Lake Bacteria Professional Grade 89
WFV Poly Pipe Roll 126
Woven Microgrid Geotextile 122



1200 Creditstone Rd., Unit 1 • Concord, Ontario L4K 5T2
Toll Free: (866) 766-3426
Customer Service Fax: (905) 454-7310
Email: customerservicecanada@aquascapeinc.com

2020 Aquascape, Inc.
All Worldwide Rights Reserved.



Find Us on Facebook
facebook.com/aquascapeinc



Visit Us on Our Website
aquascapeinc.com



Be Inspired on Pinterest
pinterest.com/aquascapeinc



Pondside Monthly E-Newsletter
aquascapeinc.com/pondside-monthly-e-newsletter



Follow Us on YouTube
youtube.com/aquascape4



Aquascape Lifestyles E-Magazine
aquascapeinc.com/aquascape-lifestyles-magazine



Greg Wittstock, The Pond Guy Vlog
youtube.com/gregwittstockthepondguy



TEAM Aquascape Vlog
youtube.com/TEAMAquascape



Ed The Pond Professor Vlog
youtube.com/edthepondprofessor